

HW Series



Complete with finger-safe contact blocks.
Ensure safety and save wiring time.



- DC-DC converter types are not approved by standards.
- See website for details on approvals and standards.

ISO3864-4 safety color compliant

Safety colors are defined with ISO standards.
The bright and clears colors are suited for emergency situations

*Except for products below

- Illuminated selector switches (illumination color: S (Blue), PW (Pure white))
- Illuminated pushbuttons (illumination color: S (Blue))
- Pilot lights - round flush (illumination color: S (Blue))

First in the industry! Six different colors with a single LED (LSRD)

Previously, 5 different color LEDs were required but with the new illuminated unit, only a single LED is used.
Only the lens needs to be replaced to change the illumination color.

The new LED reduces maintenance time, makes stock control easier, and is environmentally friendly.

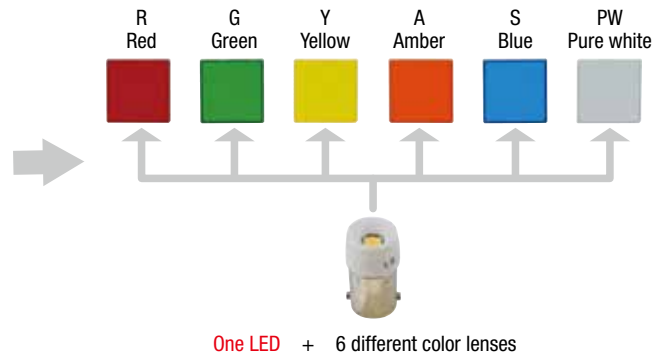
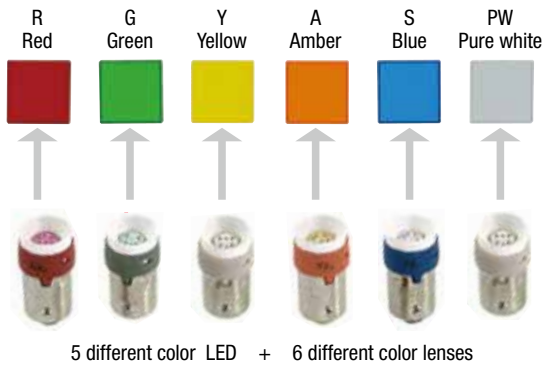

High visibility with new LED (LSRD)

Brighter and clearer compared to conventional LEDs

Conventional LEDs



New LEDs



HW Series Selection Guide

Function	Pushbutton				
Category	Flush	Extended	ø29mm Mushroom	ø40mm Mushroom	ø60mm Mushroom
	Momentary/Maintained	Momentary/Maintained	Momentary/Maintained	Momentary/Maintained	Momentary
Shape					
Model	HW1B-M1 HW1B-A1	HW1B-M2 HW1B-A2	HW1B-M3 HW1B-A3	HW1B-M4 HW1B-A4	HW1B-M5
Page	B-187	B-187	B-187	B-187	B-187

Function	Pushbutton				
Category	Square Flush	Square Extended	Round Flush w/Square Bezel	Round Extended w/Square Bezel	ø29mm Mushroom w/Square Bezel
	Momentary/Maintained	Momentary/Maintained	Momentary/Maintained	Momentary/Maintained	Momentary/Maintained
Shape					
Model	HW2B-M1 HW2B-A1	HW2B-M2 HW2B-A2	HW3B-M1 HW3B-A1	HW3B-M2 HW3B-A2	HW3B-M3 HW3B-A3
Page	B-188	B-188	B-189	B-189	B-189

Function	Pilot Light			
Category	Flush (Marking)	Extended (Dome)	Square Flush (Marking)	Jumbo Dome
Shape				
Model	HW1P-1	HW1P-2	HW2P-1	HW1P-5
Page	B-190	B-190	B-190	B-190

Function	Illuminated Pushbutton				
Category	Flush	Extended	Extended w/Full Shroud	Square Flush	Flush w/Square Bezel
	Momentary/Maintained	Momentary/Maintained	Momentary/Maintained	Momentary/Maintained	Momentary/Maintained
Shape					
Model	HW1L-M1 HW1L-A1	HW1L-M2 HW1L-A2	HW1L-MF2 HW1L-AF2	HW2L-M1 HW2L-A1	HW3L-M1 HW3L-A1
Page	B-192	B-192	B-193	B-194	B-194





Function	Illuminated Pushbutton		
Category	Flush	Extended	Extended w/Full Shroud
	Momentary/Maintained	Momentary/Maintained	Momentary/Maintained
Shape			
Model	HW1L-M3 HW1L-A3	HW3L-M3 HW3L-A3	HW1L-M4 HW1L-A4
Page	B-195	B-195	B-196



- APEM
- Switches & Pilot Lights
- Control Boxes
- Emergency Stop Switches
- Enabling Switches
- Safety Products
- Explosion Proof
- Terminal Blocks
- Relays & Sockets
- Circuit Protectors
- Power Supplies
- LED Illumination
- Controllers
- Operator Interfaces
- Sensors
- AUTO-ID



- Flush Silhouette
- ø16
- ø22
- ø30
- Miniature
- Pilot Lights

- HW
- TW
- YW

HW Series Selection Guide

Function	Dual Pushbutton			
	w/o Pilot Light		w/ Pilot Light	
Category	Flush (top) Flush (bottom)	Flush (top) Extended (bottom)	Flush (top) Flush (bottom)	Flush (top) Flush (bottom)
	Momentary/Interlocking	Momentary/Interlocking	Momentary/Interlocking	Momentary/Interlocking
Shape				
Model	HW7D-B11 HW7D-B21	HW7D-B12 HW7D-B22	HW7D-L11 HW7D-L21	HW7D-L12 HW7D-L22
Page	B-199	B-199	B-200	B-200

Function	Selector Switch			Illuminated Selector		Pushbutton Selector
	Selector	Pin Tumbler Key	Disc Tumbler Key	Knob Operator	Lever Operator	
Shape						
Model	HW1S	HW1K-□P	HW1K	HW1F	HW1F-□L	HW1R
Page	B-203	B-204	B-206	B-208	B-209	B-214

Function	Mono-Lever Switch	
	Standard	Interlocking
Shape		
Model	HW1M	HW1M-L
Page	B-215	B-215

ø22 HW Series Switches & Pilot Lights

Complete with finger-safe contact blocks Ensure safety and save wiring time

- Finger-safe terminal blocks
- Self-cleaning rolling action contacts.
- Degree of protection: IP65 (except dual pushbutton: IP40)
- Dual pushbutton switches available with two pushbuttons and a pilot light integrated into one space-saving unit.
- A wide range of operating voltages for worldwide application.
- Six different colors with a single LED (LSRD). Only the lens needs to be replaced to change the illumination color.
- ISO3864-4 safety color compliant
The bright and clear colors are suited for emergency situations



Application for dual pushbuttons:

Ideal for use as power switches and start/stop switches (available with I/ON and O/OFF markings on the buttons and a pilot light in the center).
Interlock type prevents two pushbuttons from being pressed at the same time, providing the best solution for up/down switches.

APEM

Switches & Pilot Lights

Control Boxes

Emergency Stop Switches

Enabling Switches

Safety Products

Explosion Proof

Terminal Blocks

Relays & Sockets

Circuit Protectors

Power Supplies

LED Illumination

Controllers

Operator Interfaces

Sensors

AUTO-ID

Flush Silhouette

ø16

ø22

ø30

Miniature

Pilot Lights

HW

TW

YW

Specifications and Ratings

Contact Ratings

Pushbuttons Illuminated Pushbuttons Dual Pushbuttons Selector Switches Illuminated Selector Switches Selector Pushbuttons	Rated insulation voltage	600V
	Rated continuous current	10A
	Contact ratings by utilization category IEC60947-5-1	AC-15 (A600) DC-13

Contact Ratings by Utilization Category

HW-U10 (NO contact), HW-U01 (NC contact)

Operating Voltage		24V	48V	50V	110V	220V	440V	
Operating Current	AC 50/60 Hz	AC-12 Control of resistive loads and solid state loads	10A	—	10A	10A	6A	2A
		AC-15 Control of electromagnetic loads (> 72 VA)	10A	—	7A	5A	3A	1A
	DC	DC-12 Control of resistive loads and solid state loads	10A	5A	—	2.2A	1.1A	—
		DC-13 Control of electromagnets	5A	2A	—	1.1A	0.6A	—

HW-U10R (EM contact/NO contact), HW-U01R (LB contact/NC contact)

Operating Voltage		24V	48V	50V	110V	220V	440V	
Operating Current	AC 50/60 Hz	AC-12 Control of resistive loads and solid state loads	5A	—	5A	5A	3A	1A
		AC-15 Control of electromagnetic loads (> 72 VA)	5A	—	3.5A	2.5A	1.5A	0.5A
	DC	DC-12 Control of resistive loads and solid state loads	5A	2.5A	—	1.1A	0.55A	—
		DC-13 Control of electromagnets	2.5A	1A	—	0.55A	0.3A	—

- The operating current represents the classification by making and breaking currents (IEC 60947-5-1).
- Contact materials: Silver contacts
- Minimum applicable load: 3V AC/DC, 5 mA (applicable range may vary with operating conditions and load types)



Download catalogs and CAD from <http://eu.idec.com/downloads>

ø22 HW Series Switches & Pilot Lights

HW-U Contact Block

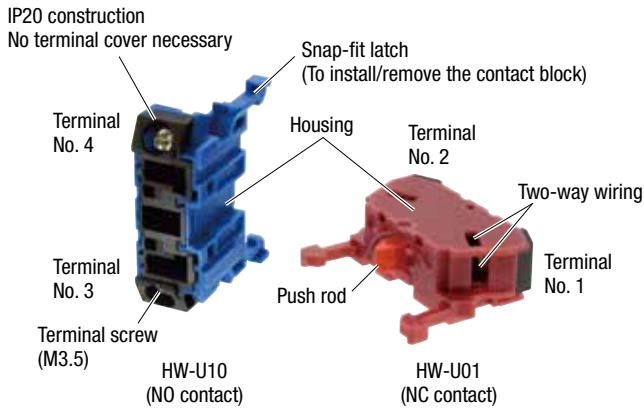

Part No.	HW-U10	HW-U01	HW-U10R	HW-U01R
Contact				
Contact No.	1NO	1NC	EM (NO) (early make)	LB (NC) (late break)
Contact No.	3-4	1-2	3-4	1-2
Housing	Blue	Purple red	Blue	Purple red
Push Rod	Green	Red	Black	White
Weight	Approx. 11g			

- Up to 2 layers (4 blocks) can be attached.
- Gold contacts available (gold-plated silver)

LED Illuminated Part Specifications

Unit	Rated Voltage		Operating Voltage		LED lamp	
					Lamp Base	Part No.
Illuminated pushbutton Illuminated selector switch Pilot light Dual pushbutton (with pilot light)	6V AC/DC		6V AC/DC		BA9S/13	LSRD-6
	12V AC/DC		12V AC/DC			LSRD-1
	24V AC/DC		24V AC/DC			LSRD-2
	100/110V AC		100/110V AC		±10%	LSRD-6
	115/120V AC		115/120V AC (*1)			
	200/220V AC		200/220V AC			
	230/240V AC		230/240V AC (*1)			
	380V AC		380V AC			
	400/440V AC		400/440V AC			
	480V AC		480V AC			
110V DC		90 to 140V DC				

- See **B-182**. for details on LED lamp ratings.
- For the LED lamp used in jumbo dome pilot lights and dual pushbutton switches (with pilot light), see **B-182**.
- Yellow (Y) cannot be used with dual pushbuttons.

Illuminated Part Type and Shape

	Illuminated Unit				Pilot Light		
	Full voltage adapter	Transformer		DC-DC converter	Full voltage adapter	Transformer	DC-DC converter
Power Unit	6, 12, 24V AC/DC	100 to 240V AC	380V AC min.	110V DC	6, 12, 24V AC/DC	100 to 480V AC	110V DC
Rated Voltage	6, 12, 24V AC/DC	100 to 240V AC	380V AC min.	110V DC	6, 12, 24V AC/DC	100 to 480V AC	110V DC
Polarity	None	None	None	X1 (+) X2 (-)	None	None	X1 (+) X2 (-)
Shape/Terminal							

LED Lamp Ratings

LSRD - Except jumbo dome pilot lights, and dual pushbutton switches (with pilot light)

Part No.	LSRD-6			LSRD-1		LSRD-2		
Lamp Base	BA9S/13							
Rated Voltage	6V AC/DC			12V AC/DC		24V AC/DC		
Voltage Range	6V AC/DC ±10%			12V AC/DC ±10%		24V AC/DC ±10%		
Current Draw	DC	10mA			7mA		7mA	
	AC	14mA			8mA		8mA	
Voltage Marking	Die stamped on the base							
Life (reference value)	Approx. 50,000 hours (The luminance is reduced to 50% the initial intensity when used on complete DC at 25°C.)							
Internal Circuit				Example: LSRD-2 				
Weight	Approx. 2g							

• Only one color is available for LSRD so there are no codes to specify the color in the part no.

LSTDB - For jumbo dome pilot lights HW1P-5Q4 only

Part No.	LSTDB-2*		
Lamp Base	BA9S/13		
Voltage Range	24V AC/DC±10%		
Current Draw	15mA		
Rated Voltage	24V AC/DC		
Life (reference value)	Approx. 20,000 hours (The luminance is reduced to 50% the initial intensity when used on complete DC at 25°C.)		
Internal Circuit	R, A 		G, S, PW

- Specify a color code in place of *. R (red), G (green), A (amber), S (blue), PW (pure white)
- Use a pure white (PW) LED for yellow (Y) illumination.

LSTD - For HW7D dual pushbutton switches (with pilot light)

Part No.	LSTD-6*			LSTD-1*		LSTD-2*		
Lamp Base	BA9S/13							
Rated Voltage	6V AC/DC			12V AC/DC		24V AC/DC		
Voltage Range	6V AC/DC ±10%			12V AC/DC ±10%		24V AC/DC ±10%		
Current Draw	Color	R, A	G, PW	S	R, G, A, PW	S	R, G, A, PW	S
	DC	7mA	5.5mA	4.5mA	10mA	8mA	10mA	8mA
	AC	8mA	8mA	7mA	11mA	9mA	11mA	9mA
Lamp Base Color	Same as illumination color (PW: gray)							
Voltage Marking	Die stamped on the base							
Life (reference value)	Approx. 50,000 hours (The luminance is reduced to 50% the initial intensity when used on complete DC at 25°C.)							
Internal Circuit				Symbols 		Example: LSTD-2PW 		
	Weight	Approx. 2g						

• Specify a color code in place of *. R (red), G (green), A (amber), S (blue), PW (pure white)

- APEM
- Switches & Pilot Lights
- Control Boxes
- Emergency Stop Switches
- Enabling Switches
- Safety Products
- Explosion Proof
- Terminal Blocks
- Relays & Sockets
- Circuit Protectors
- Power Supplies
- LED Illumination
- Controllers
- Operator Interfaces
- Sensors
- AUTO-ID
- Flush Silhouette
- ø16
- ø22
- ø30
- Miniature
- Pilot Lights

- HW
- TW
- YW

ø22 HW Series Switches and Pilot Lights

Specifications

Operating Temperature	Non-illuminated: -25 to +60°C (no freezing) Illuminated: -25 to +50°C (no freezing) Jumbo dome pilot lights: -25 to +55°C (no freezing)
Operating Humidity	45 to 85% RH (no condensation)
Storage Temperature	-40 to +80°C (no freezing)
Contact Resistance	50 mΩ maximum (initial value)
Insulation Resistance	100 MΩ minimum (500V DC megger)
Dielectric Strength	Between live and dead metal parts: 2,500V AC, 1 minute (Full voltage and illuminated units: 2,000V AC, 1 minute) (*1)
Vibration Resistance	Damage limits: 30 Hz, amplitude 1.5 mm Operating extremes: 5 to 55 Hz, amplitude 0.5 mm
Shock Resistance	Damage limits: 1,000m/s ² Operating extremes: 100m/s ²
Mechanical Life (minimum operations)	Pushbutton, Illuminated pushbutton Momentary ······ 5,000,000 Maintained ······ 500,000 Dual pushbutton ······ 500,000 Selector switch ······ 500,000 Key selector switch (Disc tumbler) ······ 500,000 Key selector switch (Pin tumbler) ······ 100,000 Illuminated selector switch ······ 500,000 Pushbutton selector ······ 250,000 Mono-lever switches ······ 250,000
Electrical Life (*5)	Pushbutton, Illuminated pushbutton Momentary ······ 500,000 (*2) Maintained ······ 500,000 (*4) Dual pushbutton ······ 500,000 (*2) Selector switch ······ 500,000 (*3) Key selector switch (Disc tumbler) ······ 500,000 (*3) Key selector switch (Pin tumbler) ······ 100,000 (*3) Illuminated selector switch ······ 500,000 (*3) Pushbutton selector ······ 250,000 (*3) Mono-lever switches ······ 250,000 (*4)
Weight (Apporox.)	66g (HW1B-M122) 20g (HW1P-1Q4) 84g (HW1L-M122Q4) 66g (HW1S-2T22) 94g (HW1K-2A22) 72g (HW1K-2JPC11) 84g (HW1F-222Q4) 71g (HW1R-2A22) 82g (HW1M-2222-22N9) 72g (HW7D-B111111) 90g (HW7D-L111111Q4)

*1) Dielectric strength for dual pushbuttons are as follows:
Full voltage type: 1,000V AC, 1 minute (between live and dead metal parts)
Transformer and DC-DC converter types: 2,000V AC, 1 minute (between live and dead metal parts)

*2) Switching frequency 1,800 operations/h, duty ratio 40%

*3) Switching frequency 1,200 operations/h, duty ratio 40%

*4) Switching frequency 900 operations/h, duty ratio 40%

*5) Load condition 220V AC, 3A (AC-15)

Mounting Hole Layout

All dimensions in mm.

Panel Cut (IEC60947-5-1)

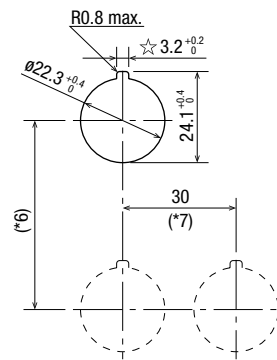

- The minimum mounting centers are applicable to switches with one layer of contact blocks (one to two contact blocks). When two layers of contact blocks are mounted, determine the minimum mounting centers in consideration of convenience for wiring.
- When high temperature is expected, take necessary measures such as securing sufficient mounting centers or using a cooling fan.

Minimum Mounting Centers

(Dimensions in mm)

Unit	A (*6)	B (*7)
ø40mm mushroom button	50	40
Pushbutton selector	50	50
Mono-lever switch	72	72
Pilot light	30	30
Jumbo dome pilot light	85	85
Dual pushbutton switch	55	30
Illuminated selector switch	50	50

- When using the safety lever lock, determine the vertical spacing (*6) in consideration of convenience for installing and removing the safety lever lock. (Recommended vertical spacing: 100 mm)
The minimum length of vertical spacing (*6) is 45 mm when safety lever lock is not used.
- The 3.2 mm recess is for preventing rotation and is not necessary when the nameplate or anti-rotation ring is not used.

Degree of Protection

Unit	IEC 60529
All units except dual pushbutton switches	IP65 (*8)
Dual pushbutton switches	IP40 (*9)

*8) When using a nameplate with the HW series, IP65 protection degree is achieved only when nameplates shown on B-216 are used. (IP40 when other ø22 namplates such as NWA are used)

*9) IP65 protection degree when HW9Z-D7D button cover is used.

Ordering Information

Standard models

- Specify Ordering No. when ordering.
- Specify a button or lens color code in place of *.
- Pilot lights, illuminated pushbuttons, and illuminated selector switches have an LED lamp installed unless otherwise specified.
- Nameplates and accessories for mono-lever switch are ordered separately. See B-216 to B-218.

Ordering Information

Pushbuttons (B-187 to B-189)

When specifying gold-plated silver contact and contact configuration:

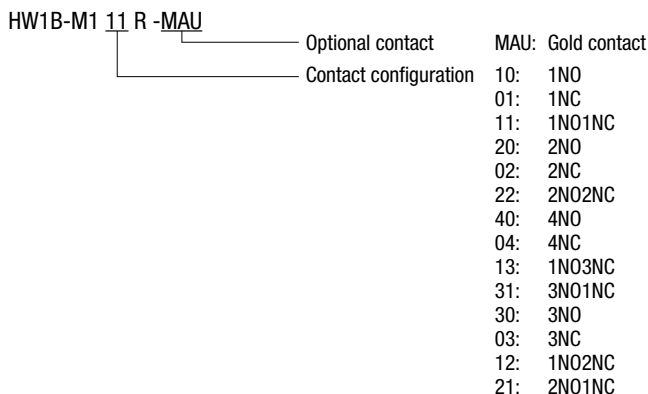

Pilot Lights (B-190)

When specifying LED operating voltage:

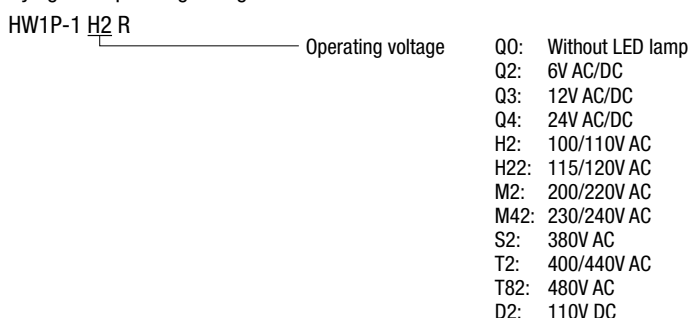

Illuminated Pushbuttons (B-192 to B-196)

When specifying gold-plated silver contact, contact configuration, and LED operating voltage:

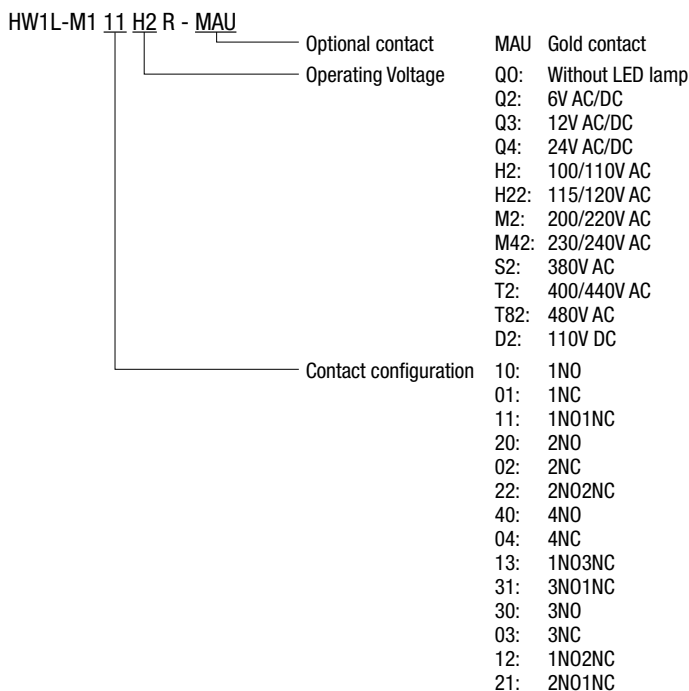

Note:

- Odd number of contact blocks, such as 1NO, 1NC, 3NO, 2NO-1NC, 1NO-2NC, and 3NC, is not available for transformer type or DC-DC converter type.

APEM

Switches & Pilot Lights

Control Boxes

Emergency Stop Switches

Enabling Switches

Safety Products

Explosion Proof

Terminal Blocks

Relays & Sockets

Circuit Protectors

Power Supplies

LED Illumination

Controllers

Operator Interfaces

Sensors

AUTO-ID

Flush Silhouette

ø16

ø22

ø30

Miniature

Pilot Lights

HW

TW

YW



Ordering Information

Dual Pushbutton Switches [without pilot light] (B-199)

When specifying gold-plated silver contact and contact configuration:

HW7D-B 1 1 10 02 GR 1-MAU

Optional contact	MAU: Gold-plated silver
Button legends	Blank: Without legend
Button color code	1: I/ON + O/OFF
Contact arrangement code (bottom button)	GR: Green (top) Red (bottom)
Contact arrangement code (top button)	WB: White (top) Black (bottom)
Button style	10: 1NO
Operation	01: 1NC
	11: 1NO1NC
	02: 2NC
	10: 1NO
	11: 1NO1NC
	20: 2NO
	1: Flush + Flush
	2: Flush + Extended
	1: Momentary
	2: Interlock

Dual Pushbutton Switches [with pilot light] (B-200)

When specifying gold-plated silver contact, contact configuration, and LED operating voltage:

HW7D-L 1 1 11 20 H2 G GR 1-MAU

Optional contact	MAU: Gold-plated silver
Button legends	Blank: Without legend
Button color code	1: I/ON + O/OFF
Lamp color code	GR: Green (top), Red (bottom)
Operating voltage	WB: White (top), Black (bottom)
Contact arrangement code (bottom button)	G: Green
Contact arrangement code (top button)	PW: Pure White
Button style	Q2: 6V AC/DC
Operation	Q3: 12V AC/DC
	Q4: 24V AC/DC
	H2: 100/110V AC
	H22: 115/120V AC
	M2: 200/220V AC
	M42: 230/240V AC
	S2: 380V AC
	T2: 400/440V AC
	T82: 480V AC
	10: 1NO
	01: 1NC
	11: 1NO1NC
	02: 2NC
	10: 1NO
	11: 1NO1NC
	20: 2NO
	1: Flush + Flush
	2: Flush + Extended
	1: Momentary
	2: Interlock

Note: Only the below combinations are possible.

Contact configuration	
Top button	Button button
1NO	1NC
1NO	1NO
1NO-1NC	1NO-1NC
2NO	2NC

Ordering Information

Key Selector Switches (Pin Tumbler Key) (B-204 to B-205)

When specifying gold-plated silver contact, key removal position, and key number:

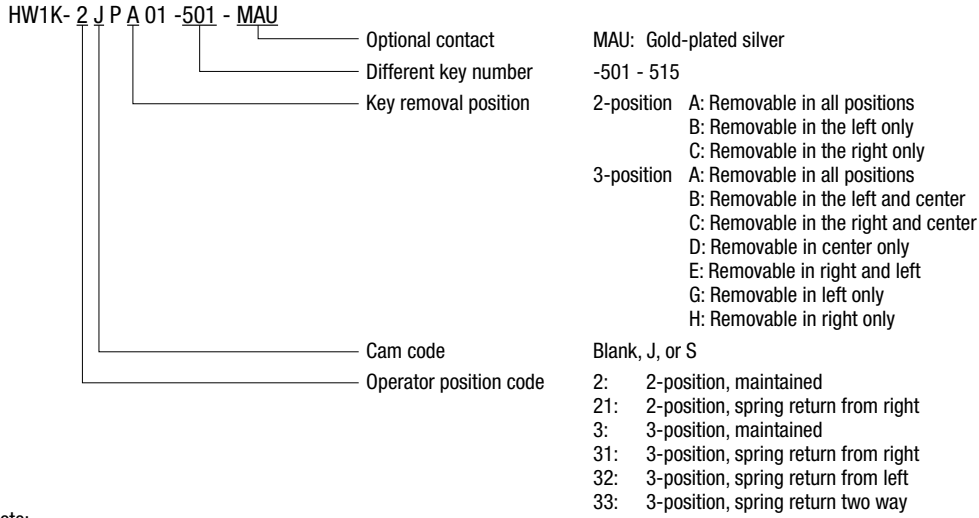

Note:

- The key cannot be removed in a spring return position.
- The key number is engraved on the key cylinder. (default key is not engraved with a number)

Key Selector Switches (Disc Tumbler Key) (B-206 to B-207)

When specifying gold-plated silver contact, key removal position, and key number:

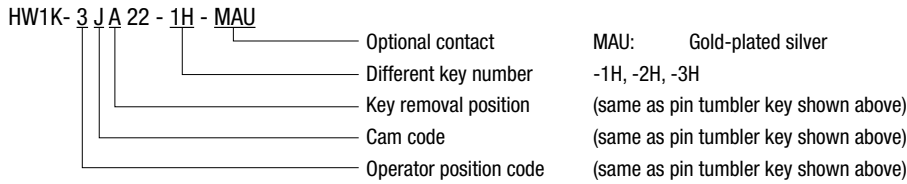

Note:

- The key cannot be removed in a spring return position.
- The key number is engraved on the key cylinder. (default key is not engraved with a number)

Illuminated Selector Switches (B-208 to B-209)

When specifying gold-plated silver contact and LED operating voltage:

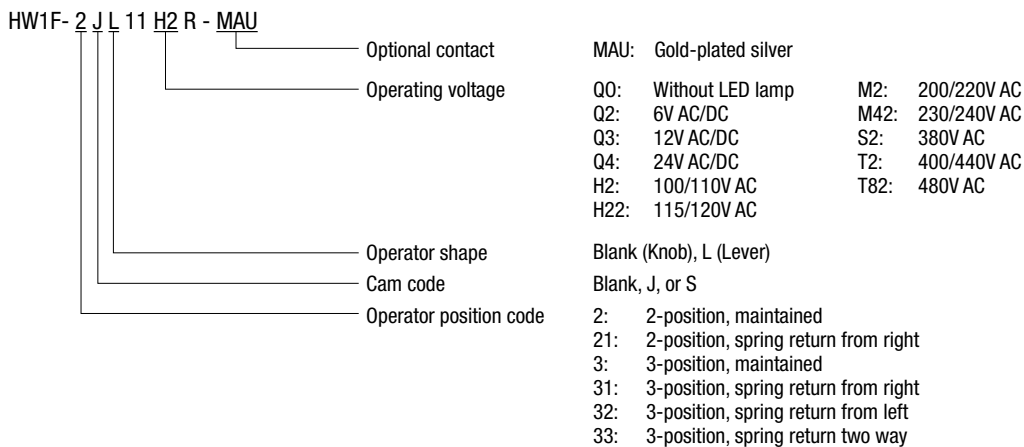

Selector Switches (B-203)

When specifying gold-plated silver contact



- See B-203 for operator position.

APEM

Switches & Pilot Lights

Control Boxes

Emergency Stop Switches

Enabling Switches

Safety Products

Explosion Proof

Terminal Blocks

Relays & Sockets

Circuit Protectors

Power Supplies

LED Illumination

Controllers

Operator Interfaces

Sensors

AUTO-ID

Flush Silhouette

ø16

ø22

ø30

Miniature

Pilot Lights







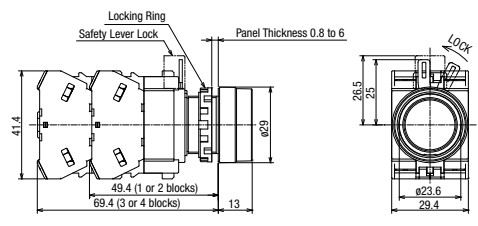

HW

TW

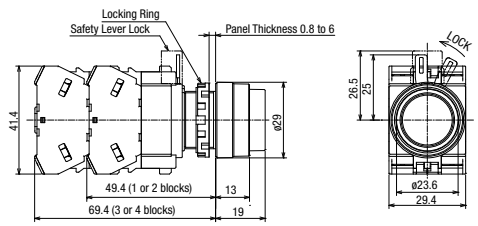
YW

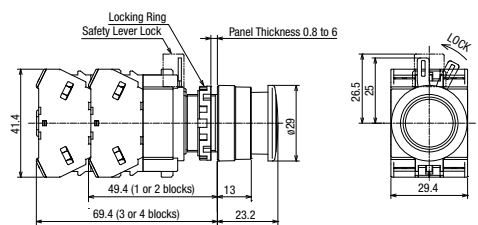
Flush / Extended / Mushroom Pushbuttons

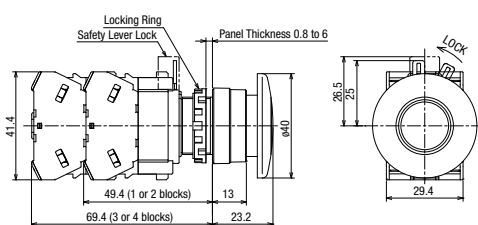

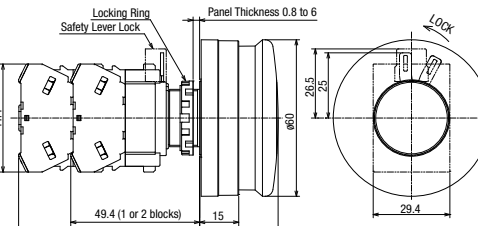
Package Quantity: 1

Shape	Operation	Contact	Part No.	Color Code	Dimensions (mm)
Flush HW1B-M1 HW1B-A1 	Momentary	1NO	HW1B-M110*	B G R Y S W	
		1NC	HW1B-M101*		
		1NO-1NC	HW1B-M111*		
		2NO	HW1B-M120*		
		2NC	HW1B-M102*		
		2NO-2NC	HW1B-M122*		
	Maintained	1NO	HW1B-A110*		
		1NC	HW1B-A101*		
		1NO-1NC	HW1B-A111*		
		2NO	HW1B-A120*		
		2NC	HW1B-A102*		
		2NO-2NC	HW1B-A122*		
Extended HW1B-M2 HW1B-A2 	Momentary	1NO	HW1B-M210*	B G R Y S W	
		1NC	HW1B-M201*		
		1NO-1NC	HW1B-M211*		
		2NO	HW1B-M220*		
		2NC	HW1B-M202*		
		2NO-2NC	HW1B-M222*		
	Maintained	1NO	HW1B-A210*		
		1NC	HW1B-A201*		
		1NO-1NC	HW1B-A211*		
		2NO	HW1B-A220*		
		2NC	HW1B-A202*		
		2NO-2NC	HW1B-A222*		
ø29mm Mushroom HW1B-M3 HW1B-A3 	Momentary	1NO	HW1B-M310*	B G R Y S W	
		1NC	HW1B-M301*		
		1NO-1NC	HW1B-M311*		
		2NO	HW1B-M320*		
		2NC	HW1B-M302*		
		2NO-2NC	HW1B-M322*		
	Maintained	1NO	HW1B-A310*		
		1NC	HW1B-A301*		
		1NO-1NC	HW1B-A311*		
		2NO	HW1B-A320*		
		2NC	HW1B-A302*		
		2NO-2NC	HW1B-A322*		
ø40mm Mushroom HW1B-M4 HW1B-A4 	Momentary	1NO	HW1B-M410*	B G R Y S W	
		1NC	HW1B-M401*		
		1NO-1NC	HW1B-M411*		
		2NO	HW1B-M420*		
		2NC	HW1B-M402*		
		2NO-2NC	HW1B-M422*		
	Maintained	1NO	HW1B-A410*		
		1NC	HW1B-A401*		
		1NO-1NC	HW1B-A411*		
		2NO	HW1B-A420*		
		2NC	HW1B-A402*		
		2NO-2NC	HW1B-A422*		
ø60mm Mushroom HW1B-M5 	Momentary	1NO	HW1B-M510*	B G R	
		1NC	HW1B-M501*		
		1NO-1NC	HW1B-M511*		
		2NO	HW1B-M520*		
		2NC	HW1B-M502*		
		2NO-2NC	HW1B-M522*		

- Specify a color code in place of * in Part No. B (black), G (green), R (red), Y (yellow), S (blue), W (white)
- Pushbuttons with 1 or 3 contact blocks have a dummy block.
- See **B-184** for other contact configurations and gold-plated silver contacts.
- Pushbuttons: M3.5 Terminal screws integrated terminal cover

Square Flush / Square Flush Pushbuttons

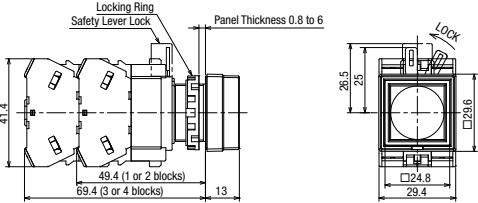
Package Quantity: 1

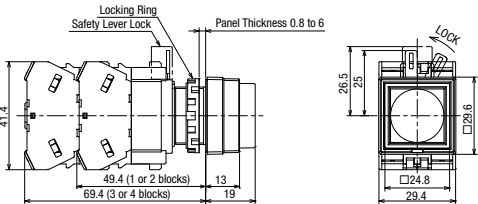
Shape	Operation	Contact	Part No.	Color Code	Dimensions (mm)
Square Flush HW2B-M1 HW2B-A1 	Momentary	1NO	HW2B-M110*	B G R Y S W	
		1NC	HW2B-M101*		
		1NO-1NC	HW2B-M111*		
		2NO	HW2B-M120*		
		2NC	HW2B-M102*		
	Maintained	1NO	HW2B-A110*		
		1NC	HW2B-A101*		
		1NO-1NC	HW2B-A111*		
		2NO	HW2B-A120*		
		2NC	HW2B-A102*		
Square Extended HW2B-M2 HW2B-A2 	Momentary	1NO	HW2B-M210*	B G R Y S W	
		1NC	HW2B-M201*		
		1NO-1NC	HW2B-M211*		
		2NO	HW2B-M220*		
		2NC	HW2B-M202*		
	Maintained	1NO	HW2B-A210*		
		1NC	HW2B-A201*		
		1NO-1NC	HW2B-A211*		
		2NO	HW2B-A220*		
		2NC	HW2B-A202*		
2NO-2NC	HW2B-A222*				

- Specify a color code in place of * in Part No. B (black), G (green), R (red), Y (yellow), S (blue), W (white)
- Pushbuttons with 1 or 3 contact blocks have a dummy block.
- See **B-184** for other contact configurations and gold-plated silver contacts.
- Pushbuttons: M3.5 Terminal screws

Bottom View

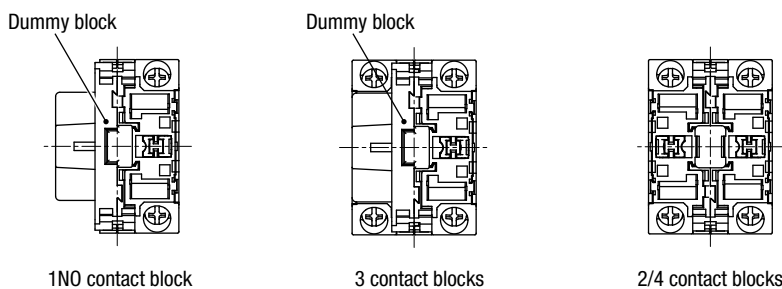

- For 1NC contact, the contact block will mount on the opposite side.
- See **B-227** for wiring.
- Integrated terminal cover

APEM

Switches & Pilot Lights

Control Boxes

Emergency Stop Switches

Enabling Switches

Safety Products

Explosion Proof

Terminal Blocks

Relays & Sockets

Circuit Protectors

Power Supplies

LED Illumination

Controllers

Operator Interfaces

Sensors

AUTO-ID

Flush Silhouette

ø16

ø22

ø30

Miniature

Pilot Lights





HW

TW

YW

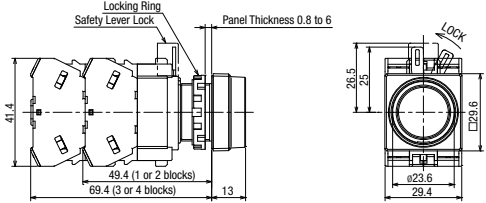
Round Flush / Round Extended /Mushroom with Square Bezel

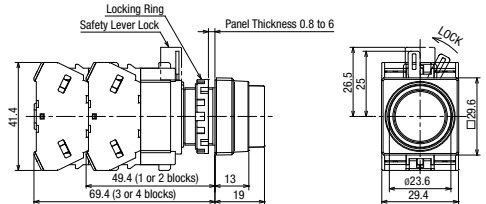
Package Quantity: 1

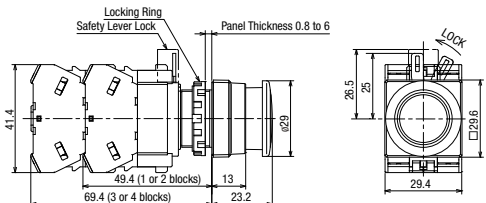
Shape	Operation	Contact	Part No.	Color Code	Dimensions (mm)
Round Flush with Square Bezel HW3B-M1 HW3B-A1 	Momentary	1NO	HW3B-M110*	B G R Y S W	
		1NC	HW3B-M101*		
		1NO-1NC	HW3B-M111*		
		2NO	HW3B-M120*		
		2NC	HW3B-M102*		
		2NO-2NC	HW3B-M122*		
	Maintained	1NO	HW3B-A110*		
		1NC	HW3B-A101*		
		1NO-1NC	HW3B-A111*		
		2NO	HW3B-A120*		
		2NC	HW3B-A102*		
		2NO-2NC	HW3B-A122*		
Round Extended with Square Bezel HW3B-M2 HW3B-A2 	Momentary	1NO	HW3B-M210*	B G R Y S W	
		1NC	HW3B-M201*		
		1NO-1NC	HW3B-M211*		
		2NO	HW3B-M220*		
		2NC	HW3B-M202*		
		2NO-2NC	HW3B-M222*		
	Maintained	1NO	HW3B-A210*		
		1NC	HW3B-A201*		
		1NO-1NC	HW3B-A211*		
		2NO	HW3B-A220*		
		2NC	HW3B-A202*		
		2NO-2NC	HW3B-A222*		
ø29mm Mushroom with Square Bezel HW3B-M3 HW3B-A3 	Momentary	1NO	HW3B-M310*	B G R Y S W	
		1NC	HW3B-M301*		
		1NO-1NC	HW3B-M311*		
		2NO	HW3B-M320*		
		2NC	HW3B-M302*		
		2NO-2NC	HW3B-M322*		
	Maintained	1NO	HW3B-A310*		
		1NC	HW3B-A301*		
		1NO-1NC	HW3B-A311*		
		2NO	HW3B-A320*		
		2NC	HW3B-A302*		
		2NO-2NC	HW3B-A322*		

- Specify a color code in place of * in Part No. B (black), G (green), R (red), Y (yellow), S (blue), W (white)
- Pushbuttons with 1 or 3 contact blocks have a dummy block.
- See **B-184** for other contact configurations and gold-plated silver contacts.
- Pushbuttons: M3.5 Terminal screws

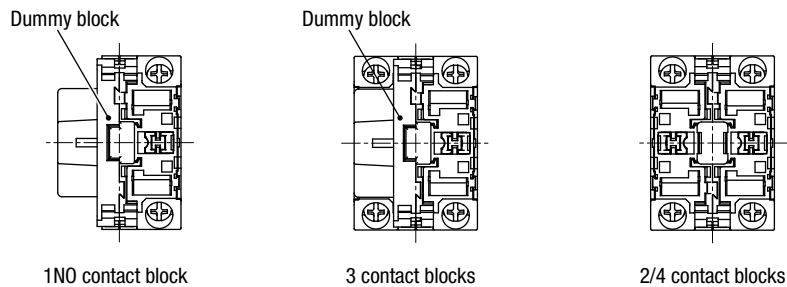

Bottom View



- For 1NC contact, the contact block will mount on the opposite side.
- See **B-227** for wiring.
- Integrated terminal cover

Round Flush / Dome / Square Flush / Jumbo Dome Pilot Lights

Package Quantity: 1

Shape	Lamp	Operating Voltage	Part No.	Color Code
Round Flush (marking type) HW1P-1  24V AC/DC  With transformer (100/110V AC)	LED	24V AC/DC	HW1P-1Q4*	R G Y A S PW
		100/110V AC	HW1P-1H2*	
		200/220V AC	HW1P-1M2*	
Dome HW1P-2  (24V AC/DC)  With transformer (100/110V AC)	LED	24V AC/DC	HW1P-2Q4*	R G Y A S PW
		100/110V AC	HW1P-2H2*	
		200/220V AC	HW1P-2M2*	
Square Flush (marking type) HW2P-1  (24V AC/DC)  With transformer (100/110V AC)	LED	24V AC/DC	HW2P-1Q4*	R G Y A S PW
		100/110V AC	HW2P-1H2*	
		200/220V AC	HW2P-1M2*	
Jumbo Dome Pilot Light (*1) HW1P-5 	LED	24V AC/DC	HW1P-5Q4*	R G Y A S PW

- Specify a color code in place of * in Part No. R (red), G (green), Y (yellow), A (amber), S (blue), PW (pure white)
 - Pilot lights have an LED lamp installed unless otherwise specified.
 - See B-184 for other operating voltages.
 - See B-191 for bottom view.
 - See B-191 for how to specify units without LED lamps.
- *1) Jumbo dome pilot lights contain an exclusive LED. See B-182 and B-221.

APEM

Switches & Pilot Lights

Control Boxes

Emergency Stop Switches

Enabling Switches

Safety Products

Explosion Proof

Terminal Blocks

Relays & Sockets

Circuit Protectors

Power Supplies

LED Illumination

Controllers

Operator Interfaces

Sensors

AUTO-ID

Flush Silhouette

ø16

ø22

ø30

Miniature

Pilot Lights

HW

TW

YW

ø22 HW Series Pilot Lights

Dimensions

All dimensions in mm.

Pilot Lights

Round Flush Terminal screws: M3.5, integrated terminal cover

6, 12, 24V AC/DC, Without LED lamp

100/110V AC, 200/220V AC (240V AC maximum)

110V DC, 380V AC minimum

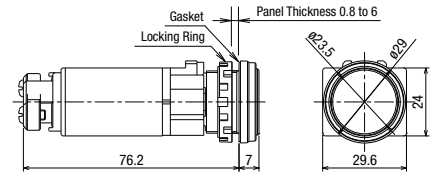
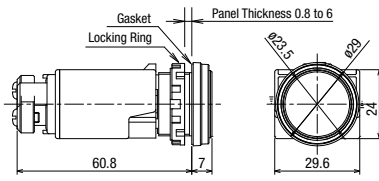
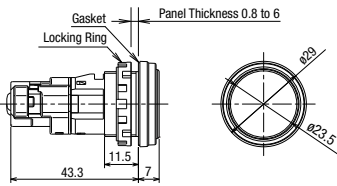

Extended Terminal screws: M3.5, integrated terminal cover

6, 12, 24V AC/DC, Without LED lamp

100/110V AC, 200/220V AC (240V AC maximum)

110V DC, 380V AC minimum

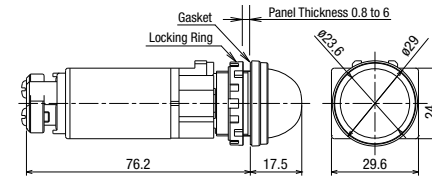
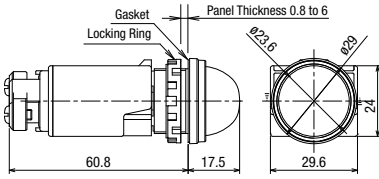
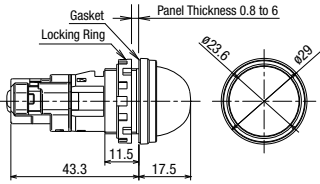

Square Flush Terminal screws: M3.5, integrated terminal cover

6, 12, 24V AC/DC, Without LED lamp

100/110V AC, 200/220V AC (240V AC maximum)

110V DC, 380V AC minimum

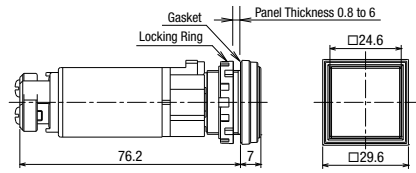
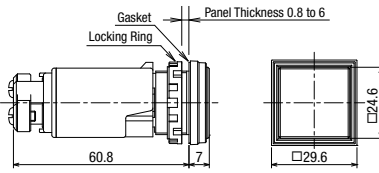
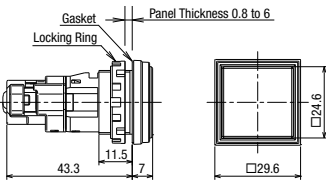

Jumbo Dome Pilot Light Terminal screws: M3.5, integrated terminal cover

Panel Thickness 1 to 5

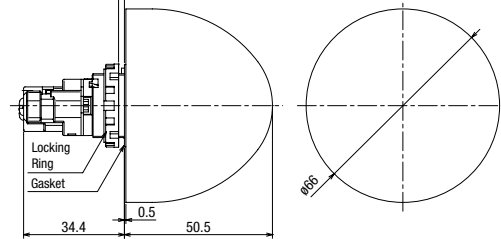

Panel Cut-Out

Mounting Centers
(Except jumbo dome)

Close mounting on 30 mm centers

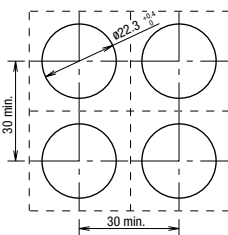

Mounting Centers
(Jumbo dome)

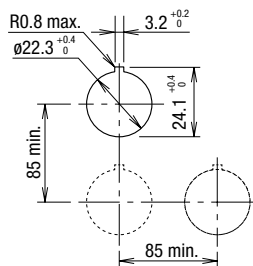

Pilot Light Bottom View

6, 12, 24V AC/DC
Without LED lamp

100/110V AC, 200/220V, 110V DC

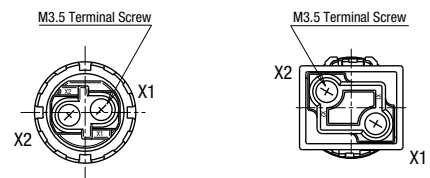





When mounting 100/110V AC, 200/220V AC, 110V DC units on 30mm centers vertically and horizontally, keep the ambient temperature below 40°C.

Determine the minimum mounting centers in consideration of convenience for wiring.

- For DC-DC Converter types, terminal X1 is ⊕, X2 is ⊖.
- See **B-228** for wiring.

LED | **Round Flush / Round Extended (Marking Type)**

Package Quantity: 1

Shape	Illumination	Operation	Rated Voltage	Contact Configuration	Part No.	Color Code	
Round Flush (Marking type) HW1L-M1 HW1L-A1  (24V AC/DC)  With transformer (100/110V AC)	LED	Momentary	24V AC/DC	1NO	HW1L-M110Q4*	R G Y A S PW	
				1NC	HW1L-M101Q4*		
				1NO-1NC	HW1L-M111Q4*		
				2NO	HW1L-M120Q4*		
				2NC	HW1L-M102Q4*		
				2NO-2NC	HW1L-M122Q4*		
			100/110V AC	1NO-1NC	HW1L-M111H2*		
				2NO	HW1L-M120H2*		
				2NC	HW1L-M102H2*		
				2NO-2NC	HW1L-M122H2*		
				200/220V AC	1NO-1NC		HW1L-M111M2*
					2NO		HW1L-M120M2*
		2NC	HW1L-M102M2*				
		2NO-2NC	HW1L-M122M2*				
		Maintained	24V AC/DC		1NO	HW1L-A110Q4*	R G Y A S PW
					1NC	HW1L-A101Q4*	
				1NO-1NC	HW1L-A111Q4*		
				2NO	HW1L-A120Q4*		
				2NC	HW1L-A102Q4*		
				2NO-2NC	HW1L-A122Q4*		
			100/110V AC	1NO-1NC	HW1L-A111H2*		
				2NO	HW1L-A120H2*		
				2NC	HW1L-A102H2*		
				2NO-2NC	HW1L-A122H2*		
200/220V AC	1NO-1NC			HW1L-A111M2*			
	2NO			HW1L-A120M2*			
	2NC	HW1L-A102M2*					
	2NO-2NC	HW1L-A122M2*					
	Round Extended (Marking type) HW1L-M2 HW1L-A2  (24V AC/DC)  With transformer (100/110V AC)	LED	Momentary	24V AC/DC	1NO	HW1L-M210Q4*	R G Y A S PW
					1NC	HW1L-M201Q4*	
1NO-1NC					HW1L-M211Q4*		
2NO					HW1L-M220Q4*		
2NC					HW1L-M202Q4*		
2NO-2NC					HW1L-M222Q4*		
100/110V AC				1NO-1NC	HW1L-M211H2*		
				2NO	HW1L-M220H2*		
				2NC	HW1L-M202H2*		
				2NO-2NC	HW1L-M222H2*		
				200/220V AC	1NO-1NC	HW1L-M211M2*	
					2NO	HW1L-M220M2*	
2NC			HW1L-M202M2*				
2NO-2NC			HW1L-M222M2*				
Maintained			24V AC/DC		1NO	HW1L-A210Q4*	R G Y A S PW
					1NC	HW1L-A201Q4*	
				1NO-1NC	HW1L-A211Q4*		
				2NO	HW1L-A220Q4*		
				2NC	HW1L-A202Q4*		
				2NO-2NC	HW1L-A222Q4*		
			100/110V AC	1NO-1NC	HW1L-A211H2*		
				2NO	HW1L-A220H2*		
				2NC	HW1L-A202H2*		
				2NO-2NC	HW1L-A222H2*		
	200/220VAC	1NO-1NC		HW1L-A211M2*			
		2NO		HW1L-A220M2*			
2NC		HW1L-A202M2*					
2NO-2NC		HW1L-A222M2*					

- Specify a color code in place of * in Part No. R (red), G (green), Y (yellow), A (amber), S (blue), PW (pure white)
- Illuminated pushbuttons have an LED lamp installed unless otherwise specified.
- See **B-184** for other operating voltage such as 6V AC/DC, 12V AC/DC, and 110V DC.
- See **B-184** for other contact configurations and gold-plated silver contacts.
- Illuminated pushbuttons of 24V AC/DC or below with 2 or 4 contact blocks have a dummy block.
- See **B-198** for bottom view.
- See **B-184** for how to specify units without LED lamps.

APEM

Switches & Pilot Lights

Control Boxes

Emergency Stop Switches

Enabling Switches

Safety Products

Explosion Proof

Terminal Blocks

Relays & Sockets

Circuit Protectors

Power Supplies

LED Illumination

Controllers

Operator Interfaces

Sensors

AUTO-ID

Flush Silhouette

ø16

ø22

ø30

Miniature

Pilot Lights

HW

TW



YW

ø22 HW Series Illuminated Pushbuttons

LED

Round Extended with Full Shroud (Marking Type)





Package Quantity: 1

Shape	Illumination	Operation	Rated Voltage	Contact	Part No.	Color Code		
Round Extended with Full Shroud (Marking type) HW1L-MF2 HW1L-AF2  (24V AC/DC)	LED	Momentary	24V AC/DC	1NO	HW1L-MF210Q4*	R G Y A S PW		
				1NC	HW1L-MF201Q4*			
				1NO-1NC	HW1L-MF211Q4*			
				2NO	HW1L-MF220Q4*			
				2NC	HW1L-MF202Q4*			
				2NO-2NC	HW1L-MF222Q4*			
			100/110V AC	1NO-1NC	HW1L-MF211H2*			
				2NO	HW1L-MF220H2*			
				2NC	HW1L-MF220H2*			
		200/220V AC	2NO-2NC	HW1L-MF222H2*				
			1NO-1NC	HW1L-MF211M2*				
			2NO	HW1L-MF220M2*				
		 With transformer (100/110V AC)	LED	Maintained	24V AC/DC	1NO	HW1L-AF210Q4*	R G Y A S PW
						1NC	HW1L-AF201Q4*	
						1NO-1NC	HW1L-AF211Q4*	
						2NO	HW1L-AF220Q4*	
						2NC	HW1L-AF202Q4*	
						2NO-2NC	HW1L-AF222Q4*	
100/110V AC	1NO-1NC				HW1L-AF211H2*			
	2NO				HW1L-AF220H2*			
	2NC				HW1L-AF202H2*			
200/220V AC	2NO-2NC			HW1L-AF222H2*				
	1NO-1NC			HW1L-AF211M2*				
	2NO			HW1L-AF220M2*				
	2NC			HW1L-AF202M2*				
	2NO-2NC			HW1L-AF222M2*				

- Specify a color code in place of * in Part No. R (red), G (green), Y (yellow), A (amber), S (blue), PW (pure white)
- Illuminated pushbuttons have an LED lamp installed unless otherwise specified.
- See **B-184** for other operating voltage such as 6V AC/DC, 12V AC/DC, and 110V DC.
- See **B-184** for other contact configurations and gold-plated silver contacts.
- Illuminated pushbuttons of 24V AC/DC or below with 2 or 4 contact blocks have a dummy block.
- See **B-198** for bottom view.

LED Square Flush / Round Flush with Square Bezel (Marking Type)

Package Quantity: 1

Shape	Illumination	Operation	Voltage	Contact	Part No.	Color Code	
Square Flush (Marking type) HW2L-M1 HW2L-A1  (24V AC/DC)  With transformer (100/110V AC)	LED	Momentary	24V AC/DC	1NO	HW2L-M110Q4*	R G Y A S PW	
				1NC	HW2L-M101Q4*		
				1NO-1NC	HW2L-M111Q4*		
				2NO	HW2L-M120Q4*		
				2NC	HW2L-M102Q4*		
				2NO-2NC	HW2L-M122Q4*		
			100/110V AC	1NO-1NC	HW2L-M111H2*		
				2NO	HW2L-M120H2*		
				2NC	HW2L-M102H2*		
				2NO-2NC	HW2L-M122H2*		
				200/220V AC	1NO-1NC		HW2L-M111M2*
					2NO		HW2L-M120M2*
		2NC	HW2L-M102M2*				
		2NO-2NC	HW2L-M122M2*				
		Maintained	24V AC/DC		1NO	HW2L-A110Q4*	R G Y A S PW
					1NC	HW2L-A101Q4*	
				1NO-1NC	HW2L-A111Q4*		
				2NO	HW2L-A120Q4*		
				2NC	HW2L-A102Q4*		
				2NO-2NC	HW2L-A122Q4*		
			100/110V AC	1NO-1NC	HW2L-A111H2*		
				2NO	HW2L-A120H2*		
				2NC	HW2L-A102H2*		
				2NO-2NC	HW2L-A122H2*		
200/220V AC	1NO-1NC			HW2L-A111M2*			
	2NO			HW2L-A120M2*			
	2NC	HW2L-A102M2*					
	2NO-2NC	HW2L-A122M2*					
	Round Flush with Square Bezel (Marking type) HW3L-M1 HW3L-A1  (24V AC/DC)  With transformer (100/110V AC)	LED	Momentary	24V AC/DC	1NO	HW3L-M110Q4*	R G Y A S PW
					1NC	HW3L-M101Q4*	
1NO-1NC					HW3L-M111Q4*		
2NO					HW3L-M120Q4*		
2NC					HW3L-M102Q4*		
2NO-2NC					HW3L-M122Q4*		
100/110V AC				1NO-1NC	HW3L-M111H2*		
				2NO	HW3L-M120H2*		
				2NC	HW3L-M102H2*		
				2NO-2NC	HW3L-M122H2*		
				200/220V AC	1NO-1NC	HW3L-M111M2*	
					2NO	HW3L-M120M2*	
2NC			HW3L-M102M2*				
2NO-2NC			HW3L-M122M2*				
Maintained			24V AC/DC		1NO	HW3L-A110Q4*	R G Y A S PW
					1NC	HW3L-A101Q4*	
				1NO-1NC	HW3L-A111Q4*		
				2NO	HW3L-A120Q4*		
				2NC	HW3L-A102Q4*		
				2NO-2NC	HW3L-A122Q4*		
			100/110V AC	1NO-1NC	HW3L-A111H2*		
				2NO	HW3L-A120H2*		
				2NC	HW3L-A102H2*		
				2NO-2NC	HW3L-A122H2*		
	200/220V AC	1NO-1NC		HW3L-A111M2*			
		2NO		HW3L-A120M2*			
2NC		HW3L-A102M2*					
2NO-2NC		HW3L-A122M2*					

- Specify a color code in place of * in Part No. R (red), G (green), Y (yellow), A (amber), S (blue), PW (pure white)
- Illuminated pushbuttons have an LED lamp installed unless otherwise specified.
- See B-184 for other operating voltage such as 6V AC/DC, 12V AC/DC, and 110V DC.
- See B-184 for other contact configurations and gold-plated silver contacts.
- Illuminated pushbuttons of 24V AC/DC or below with 2 or 4 contact blocks have a dummy block.
- See B-198 for bottom view.

APEM

Switches & Pilot Lights

Control Boxes

Emergency Stop Switches

Enabling Switches

Safety Products

Explosion Proof

Terminal Blocks

Relays & Sockets

Circuit Protectors

Power Supplies

LED Illumination

Controllers

Operator Interfaces

Sensors

AUTO-ID

Flush Silhouette

ø16

ø22

ø30

Miniature

Pilot Lights

HW

TW



YW

ø22 HW Series Illuminated Pushbuttons

LED

Mushroom (ø29mm) / Mushroom (ø29mm) with Square Bezel (Marking Type)

Package Quantity: 1

Shape	Illumination	Operation	Illumination	Contact	Part No.	Color Code	
ø29mm Mushroom (Marking type) HW1L-M3 HW1L-A3  (24V AC/DC)	LED	Momentary	24V AC/DC	1NO	HW1L-M310Q4*	R G Y A S PW	
				1NC	HW1L-M301Q4*		
				1NO-1NC	HW1L-M311Q4*		
				2NO	HW1L-M320Q4*		
				2NC	HW1L-M302Q4*		
				2NO-2NC	HW1L-M322Q4*		
				1NO-1NC	HW1L-M311H2*		
				2NO	HW1L-M320H2*		
				2NC	HW1L-M302H2*		
		100/110V AC	200/220V AC	24V AC/DC	1NO	HW1L-A310Q4*	R G Y A S PW
					1NC	HW1L-A301Q4*	
					1NO-1NC	HW1L-A311Q4*	
				2NO	HW1L-A320Q4*		
				2NC	HW1L-A302Q4*		
				2NO-2NC	HW1L-A322Q4*		
				1NO-1NC	HW1L-A311H2*		
				2NO	HW1L-A320H2*		
				2NC	HW1L-A302H2*		
100/110V AC	200/220V AC	24V AC/DC	1NO	HW1L-A310Q4*	R G Y A S PW		
			1NC	HW1L-A301Q4*			
			1NO-1NC	HW1L-A311Q4*			
		2NO	HW1L-A320H2*				
		2NC	HW1L-A302H2*				
		2NO-2NC	HW1L-A322H2*				
100/110V AC	200/220V AC	24V AC/DC	1NO	HW1L-A310Q4*	R G Y A S PW		
			1NC	HW1L-A301Q4*			
			1NO-1NC	HW1L-A311Q4*			
		2NO	HW1L-A320M2*				
		2NC	HW1L-A302M2*				
		2NO-2NC	HW1L-A322M2*				
ø29mm Mushroom with Square Bezel (Marking type) HW3L-M3 HW3L-A3  (24V AC/DC)	LED	Momentary	24V AC/DC	1NO	HW3L-M310Q4*	R G Y A S PW	
				1NC	HW3L-M301Q4*		
				1NO-1NC	HW3L-M311Q4*		
				2NO	HW3L-M320Q4*		
				2NC	HW3L-M302Q4*		
				2NO-2NC	HW3L-M322Q4*		
				1NO-1NC	HW3L-M311H2*		
				2NO	HW3L-M320H2*		
				2NC	HW3L-M302H2*		
		100/110V AC	200/220V AC	24V AC/DC	1NO	HW3L-A310Q4*	R G Y A S PW
					1NC	HW3L-A301Q4*	
					1NO-1NC	HW3L-A311Q4*	
				2NO	HW3L-A320Q4*		
				2NC	HW3L-A302Q4*		
				2NO-2NC	HW3L-A322Q4*		
				1NO-1NC	HW3L-A311H2*		
				2NO	HW3L-A320H2*		
				2NC	HW3L-A302H2*		
100/110V AC	200/220V AC	24V AC/DC	1NO	HW3L-A310Q4*	R G Y A S PW		
			1NC	HW3L-A301Q4*			
			1NO-1NC	HW3L-A311Q4*			
		2NO	HW3L-A320M2*				
		2NC	HW3L-A302M2*				
		2NO-2NC	HW3L-A322M2*				
100/110V AC	200/220V AC	24V AC/DC	1NO	HW3L-A310Q4*	R G Y A S PW		
			1NC	HW3L-A301Q4*			
			1NO-1NC	HW3L-A311Q4*			
		2NO	HW3L-A320M2*				
		2NC	HW3L-A302M2*				
		2NO-2NC	HW3L-A322M2*				

- Specify a color code in place of * in Part No. R (red), G (green), Y (yellow), A (amber), S (blue), PW (pure white)
- Illuminated pushbuttons have an LED lamp installed unless otherwise specified.
- See **B-184** for other operating voltage such as 6V AC/DC, 12V AC/DC, and 110V DC.
- See **B-184** for other contact configurations and gold-plated silver contacts.
- Illuminated pushbuttons of 24V AC/DC or below with 2 or 4 contact blocks have a dummy block.
- See **B-198** for bottom view.

LED Mushroom (ø40mm) (Marking Type)

Package Quantity: 1

Shape	Illumination	Operation	Illumination	Contact	Part No.	Color Code	
<p>(24V AC/DC)</p> <p>With transformer (100/110V AC)</p>	LED	Momentary	24V AC/DC	1NO	HW1L-M410Q4*	R G Y A S PW	
				1NC	HW1L-M401Q4*		
				1NO-1NC	HW1L-M411Q4*		
				2NO	HW1L-M420Q4*		
				2NC	HW1L-M402Q4*		
				2NO-2NC	HW1L-M422Q4*		
			100/110V AC	1NO-1NC	HW1L-M411H2*		
				2NO	HW1L-M420H2*		
				2NC	HW1L-M402H2*		
				2NO-2NC	HW1L-M422H2*		
				200/220V AC	1NO-1NC		HW1L-M411M2*
					2NO		HW1L-M420M2*
		2NC	HW1L-M402M2*				
		2NO-2NC	HW1L-M422M2*				
		Maintained	24V AC/DC		1NO	HW1L-A410Q4*	R G Y A S PW
					1NC	HW1L-A401Q4*	
				1NO-1NC	HW1L-A411Q4*		
				2NO	HW1L-A420Q4*		
				2NC	HW1L-A402Q4*		
				2NO-2NC	HW1L-A422Q4*		
			100/110V AC	1NO-1NC	HW1L-A411H2*		
				2NO	HW1L-A420H2*		
				2NC	HW1L-A402H2*		
				2NO-2NC	HW1L-A422H2*		
200/220V AC	1NO-1NC			HW1L-A411M2*			
	2NO			HW1L-A420M2*			
	2NC	HW1L-A402M2*					
	2NO-2NC	HW1L-A422M2*					

- Specify a color code in place of * in Part No. R (red), G (green), Y (yellow), A (Amber), S (blue), PW (pure white)
- Illuminated pushbuttons have an LED lamp installed unless otherwise specified.
- See **B-184** for other operating voltage such as 6V AC/DC, 12V AC/DC, and 110V DC.
- See **B-184** for other contact configurations and gold-plated silver contacts.
- Illuminated pushbuttons of 24V AC/DC or below with 2 or 4 contact blocks have a dummy block.
- See **B-198** for bottom view.

APEM

Switches & Pilot Lights

Control Boxes

Emergency Stop Switches

Enabling Switches

Safety Products

Explosion Proof

Terminal Blocks

Relays & Sockets

Circuit Protectors

Power Supplies

LED Illumination

Controllers

Operator Interfaces

Sensors

AUTO-ID

Flush Silhouette

ø16

ø22

ø30

Miniature

Pilot Lights

HW

TW

YW

ø22 HW Series Illuminated Pushbuttons

Dimensions

All dimensions in mm.

Illuminated Pushbuttons (Momentary / Maintained)

Round Flush Terminal screws: M3.5, integrated terminal cover

6, 12, 24V AC/DC, Without LED lamp

100/110V AC, 200/220V AC (240V maximum)

110V DC, 380V AC minimum

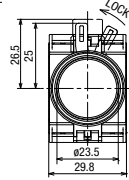
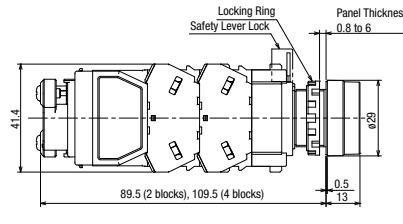
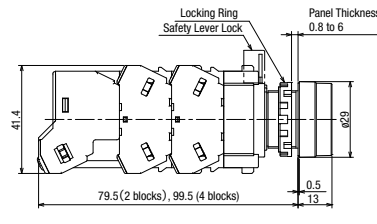
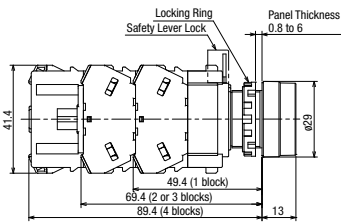

APEM

Switches & Pilot Lights

Control Boxes

Emergency Stop Switches

Enabling Switches

Safety Products

Explosion Proof

Terminal Blocks

Relays & Sockets

Circuit Protectors

Power Supplies

LED Illumination

Controllers

Operator Interfaces

Sensors

AUTO-ID

Round Extended Terminal screws: M3.5, integrated terminal cover

6, 12, 24V AC/DC, Without LED lamp

100/110V AC, 200/220V AC (240V maximum)

110V DC, 380V AC minimum

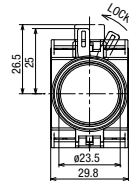
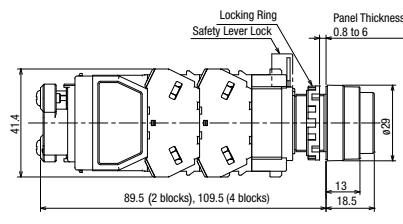
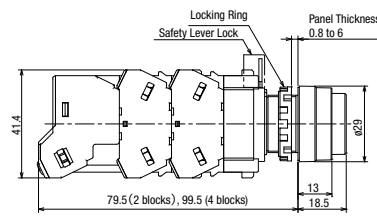
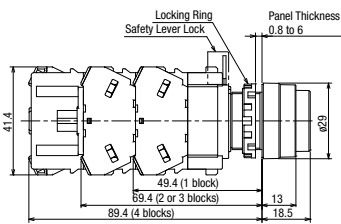

Round Extended with Full Shroud

Terminal screws: M3.5, integrated terminal cover

6, 12, 24V AC/DC, Without LED lamp

100/110V AC, 200/220V AC (240V maximum)

110V DC, 380V AC minimum

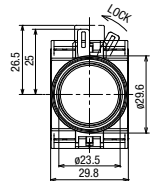
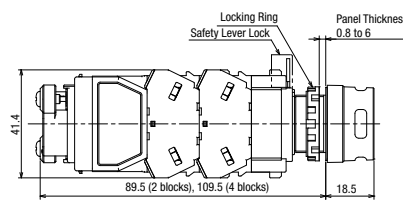
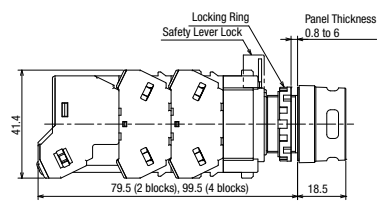
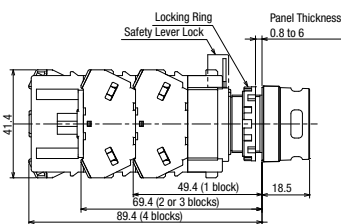

Flush Silhouette

ø16

ø22

ø30

Miniature

Pilot Lights

Square Flush Terminal screws: M3.5, integrated terminal cover

6, 12, 24V AC/DC, Without LED lamp

100/110V AC, 200/220V AC (240V maximum)

110V DC, 380V AC minimum

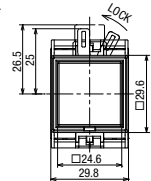
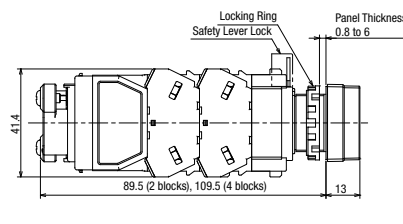
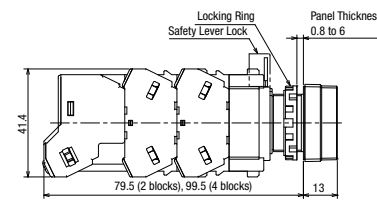
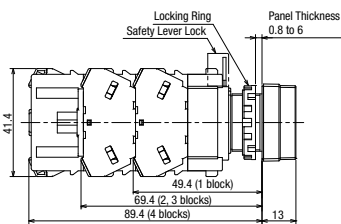

HW

TW

YW

Flush with Square Bezel Terminal screws: M3.5, integrated terminal cover

6, 12, 24V AC/DC, Without LED lamp

100/110V AC, 200/220V AC (240V maximum)

110V DC, 380V AC minimum

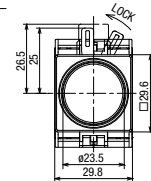
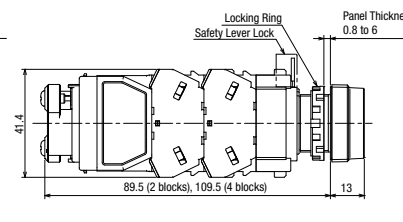
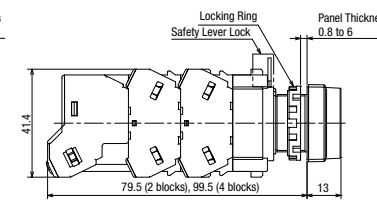
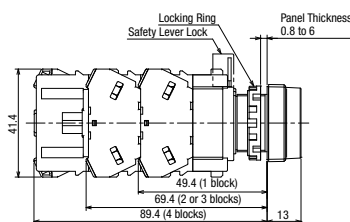

Dimensions

All dimensions in mm.

Illuminated Pushbuttons (Momentary / Maintained)

ø29mm Mushroom Terminal screws: M3.5, integrated terminal cover
 6, 12, 24V AC/DC, Without LED lamp 100/110V AC, 200/220V AC (240V maximum) 110V DC, 380V AC minimum

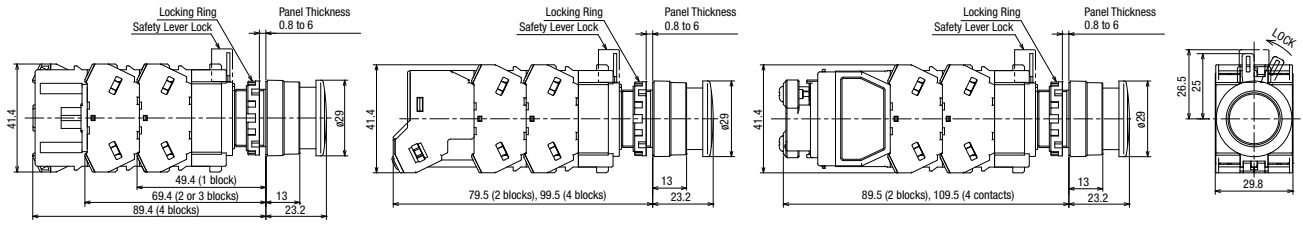

ø29mm Mushroom with Square Bezel Terminal screws: M3.5, integrated terminal cover
 6, 12, 24V AC/DC, Without LED lamp 100/110V AC, 200/220V AC (240V maximum) 110V DC, 380V AC minimum

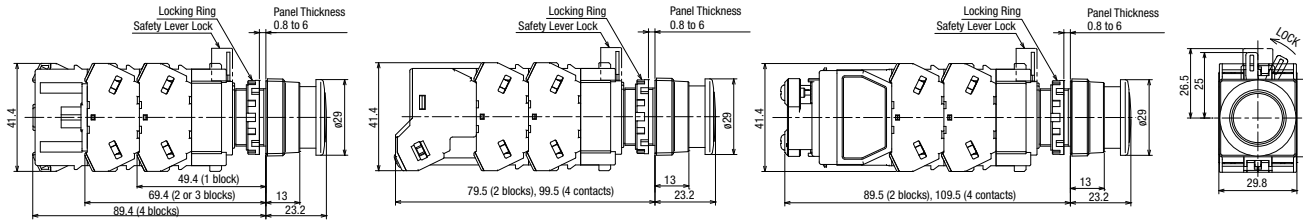

ø40mm Mushroom with Square Bezel Terminal screws: M3.5, integrated terminal cover
 6, 12, 24V AC/DC, Without LED lamp 100/110V AC, 200/220V AC (240V maximum) 110V DC, 380V AC minimum

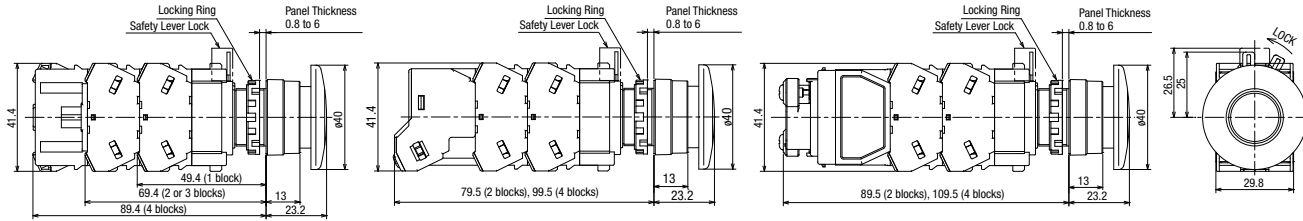

Bottom View

6, 12, 24V AC/DC, Without LED lamp

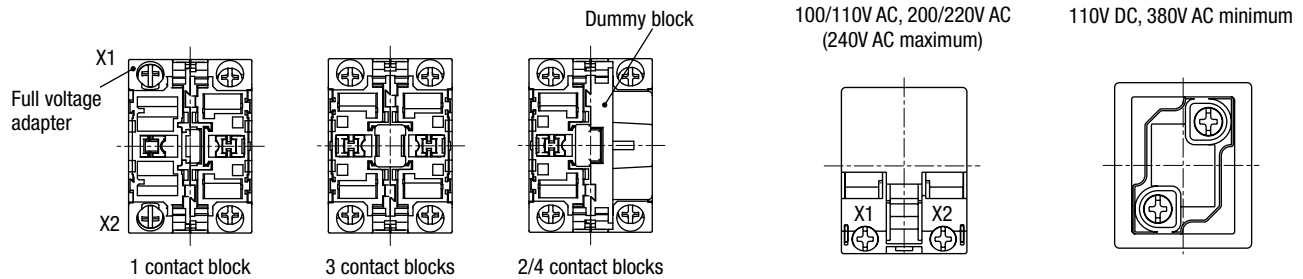

• For DC-DC Converter types, terminal X1 is ⊕, X2 is ⊖.

• See B-227 to B-228 for wiring.

APEM

Switches & Pilot Lights

Control Boxes

Emergency Stop Switches

Enabling Switches

Safety Products

Explosion Proof

Terminal Blocks

Relays & Sockets

Circuit Protectors

Power Supplies

LED Illumination

Controllers

Operator Interfaces

Sensors

AUTO-ID

Flush Silhouette

ø16

ø22

ø30

Miniature

Pilot Lights

HW

TW

YW



Dual Pushbuttons (without Pilot Light)

Specify a button color code in place of [2] and legend code in place of [3] in the Part No.

Package Quantity: 1

Operation	Button Style	Contact		Part No.	[2] Button Color Code	[3] Legend Code
		Top Button	Bottom Button			
<div style="display: flex; justify-content: space-around; align-items: center;"> <div style="text-align: center;"> <p>Shape</p> </div> </div>						
Momentary	Flush (top) Flush (bottom)	1NO	1NC	HW7D-B111001 [2][3]	GR: Green (top) Red (bottom) WB: White (top) Black (bottom)	Blank: Without legend 1: I / ON (top) O / OFF (bottom)
		1NO	1NO	HW7D-B111010 [2][3]		
		1NO-1NC	1NO-1NC	HW7D-B111111 [2][3]		
	Flush (top) Extended (bottom)	2NO	2NC	HW7D-B112002 [2][3]		
		1NO	1NC	HW7D-B121001 [2][3]		
		1NO	1NO	HW7D-B121010 [2][3]		
Interlock (*1)	Flush (top) Flush (bottom)	1NO-1NC	1NO-1NC	HW7D-B121111 [2][3]		
		2NO	2NC	HW7D-B122002 [2][3]		
		1NO	1NC	HW7D-B211001 [2][3]		
	Flush (top) Extended (bottom)	1NO	1NO	HW7D-B211010 [2][3]		
		1NO-1NC	1NO-1NC	HW7D-B211111 [2][3]		
		2NO	2NC	HW7D-B222002 [2][3]		

• See B-202 for top and bottom button contact mounting positions.

*1) Interlock: Momentary operation. When one of the buttons is pressed, the other button cannot be operated.

Do not operate top and bottom buttons at the same time. Operating the buttons at the same time may lead to malfunctions.

LED Dual Pushbuttons (with Pilot Light)

Specify a LED color code in place of [1], button color code in place of [2], and legend code in place of [3] in the Part No.

Package Quantity: 1

Shape	HW7D LED: LSTD-2* (24V AC/DC)								
	Operation	Button Style	Illumination	Contact		Part No.	[1] LED	[2] Button Color Code	[3] Legend Code
Momentary	Flush (top) Flush (bottom)	24V AC/DC	1NO	1NC	HW7D-L111001Q4	[1] [2] [3]	G PW	GR: Green (top) Red (bottom)	Blank: Without legend
			1NO	1NO	HW7D-L111010Q4	[1] [2] [3]			
			1NO-1NC	1NO-1NC	HW7D-L111111Q4	[1] [2] [3]			
	Flush (top) Extended (bottom)	24V AC/DC	2NO	2NC	HW7D-L112002Q4	[1] [2] [3]			
			1NO	1NC	HW7D-L121001Q4	[1] [2] [3]			
			1NO-1NC	1NO-1NC	HW7D-L121111Q4	[1] [2] [3]			
Interlock (*1)	Flush (top) Flush (bottom)	24V AC/DC	2NO	2NC	HW7D-L122002Q4	[1] [2] [3]			
			1NO	1NC	HW7D-L211001Q4	[1] [2] [3]			
			1NO	1NO	HW7D-L211010Q4	[1] [2] [3]			
	Flush (top) Extended (bottom)	24V AC/DC	1NO-1NC	1NO-1NC	HW7D-L211111Q4	[1] [2] [3]			
			2NO	2NC	HW7D-L212002Q4	[1] [2] [3]			
			1NO	1NC	HW7D-L221001Q4	[1] [2] [3]			
			1NO	1NO	HW7D-L221010Q4	[1] [2] [3]			
			1NO-1NC	1NO-1NC	HW7D-L221111Q4	[1] [2] [3]			
			2NO	2NC	HW7D-L222002Q4	[1] [2] [3]			

- LED lamp code: G (green), PW (pure white)
- Only W (white) lens is available.
- See **B-185** for other operating voltage such as 100/110V AC and 200/220V AC.
- See **B-185** for gold-plated silver contacts.
- Illuminated pushbuttons of 24V AC/DC or below with 2 or 4 contact blocks have a dummy block.
- See **B-202** for top and bottom button contact mounting positions.

*1) Interlock: Momentary operation. When one of the buttons is pressed, the other button cannot be operated.
Do not operate top and bottom buttons at the same time. Operating the buttons at the same time may lead to malfunctions.

APEM

Switches & Pilot Lights

Control Boxes

Emergency Stop Switches

Enabling Switches

Safety Products

Explosion Proof

Terminal Blocks

Relays & Sockets

Circuit Protectors

Power Supplies

LED Illumination

Controllers

Operator Interfaces

Sensors

AUTO-ID

Flush Silhouette

ø16

ø22

ø30

Miniature

Pilot Lights

HW

TW

YW



ø22 HW Series Dual Pushbuttons

Dimensions

All dimensions in mm.

Dual Pushbuttons

Without Pilot Light Terminal screws: M3.5, integrated terminal cover
Flush (top), Flush (bottom)

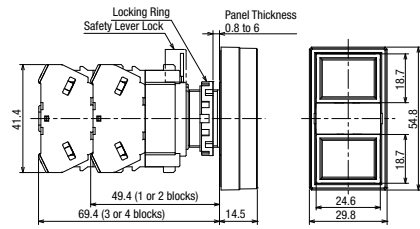

With Pilot Light Terminal screws: M3.5, integrated terminal cover
Flush (top), Flush (bottom) (24V AC/DC)

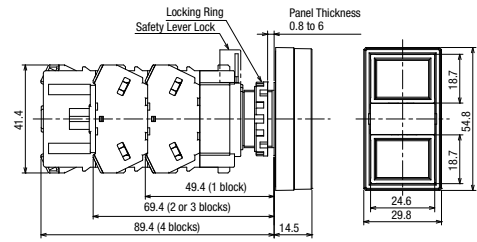

Flush (top), Extended (bottom)

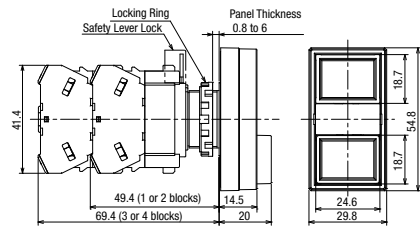

Flush (top), Flush (bottom) (240V AC maximum)

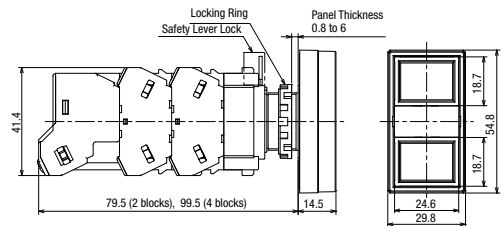

Flush (top), Extended (bottom) (with legend)

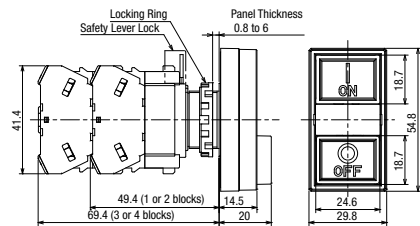

Flush (top), Flush (bottom) (380V AC minimum)

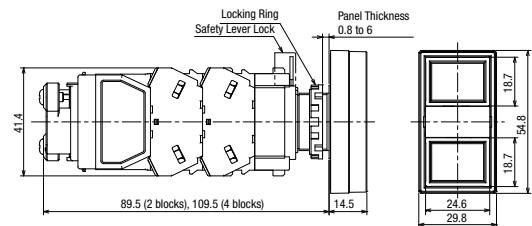

Bottom View

Without Pilot Light

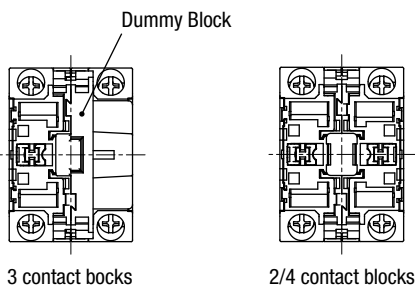

3 contact blocks

2/4 contact blocks

With Pilot Light

6, 12, 24V AC/DC

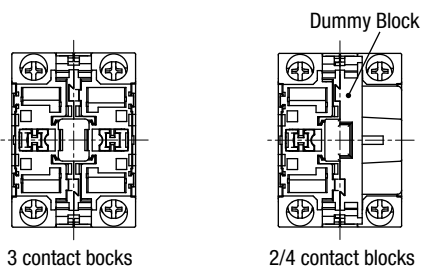

3 contact blocks

2/4 contact blocks

100/110V AC, 200/220V AC
(240V maximum)

380V AC minimum

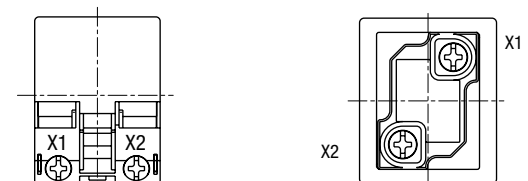

X2

X1

- See B-227 to B-228 for wiring.
- Mounting position of the dummy block may change according to the contact configuration of the top and bottom buttons.

Contact Arrangement Chart

Contact			Contact Block		Top Button		Bottom Button		
Top Button	Bottom Button	Contact Code	Mounting Position	Contact	Normal	Push	Normal	Push	
1NO	1NO	1010	①	NO		●			
			②	NO				●	
1NO	1NC	1001	①	NO		●			
			②	NC			●		
1NO-1NC	1NO-1NC	1111	①	NO		●			
			②	NO				●	
			③	NC	●				
			④	NC				●	
2NO	2NC	2002	①	NO		●			
			②	NC			●		
			③	NO		●			
			④	NC				●	

• Contact blocks ① and ③ are actuated by the top button. Contact blocks ② and ④ are actuated by the bottom button.

Contact Block		Top Button		Bottom Button	
Mounting Position	Contact	Normal	Push	Normal	Push
①	NO		●		
②	NO				●
③	NC	●			
④	NC			●	

← Button Position
← Pushbutton Operation

Contact Block Mounting Position

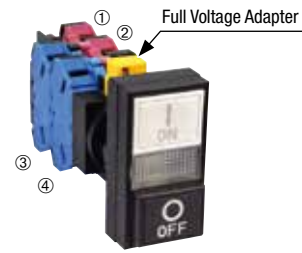

With Pilot Light (Full Voltage Type)



With Pilot Light (Transformer Type)

Part No. Example

HW7D-B121111GR

└── Contact Code

APEM

Switches & Pilot Lights

Control Boxes

Emergency Stop Switches

Enabling Switches

Safety Products

Explosion Proof

Terminal Blocks

Relays & Sockets

Circuit Protectors

Power Supplies

LED Illumination

Controllers

Operator Interfaces

Sensors

AUTO-ID

Flush Silhouette

ø16

ø22

ø30

Miniature

Pilot Lights

HW







TW

YW



Selector Switches (Knob Operator)

Package Quantity: 1

Shape	Knob Operator HW1S												
	Contact	Contact Block	Operator Position				Maintained (90°)	Spring Return from Right (60°)	—		—		
90° 2-position/ 60° 2-position	Mounting Position	Contact	1	2									
	1NO (10)	①	NO		●			HW1S-2T10	HW1S-21T10	/			
		②	—	Dummy Block									
	1NO-1NC (11)	①	NO		●			HW1S-2T11	HW1S-21T11				
		②	NC	●									
	2NO (20)	①	NO		●			HW1S-2T20	HW1S-21T20				
		②	NO		●								
	2NO-2NC (22)	①	NO		●			HW1S-2T22	HW1S-21T22				
		②	NC	●									
		③	NO		●								
	④	NC	●										
45° 3-position	Contact	Contact Block	Operator Position				Maintained	Spring Return from Right	Spring Return from Left	Spring Return Two-way			
	Mounting Position	Contact	1	0	2								
	2NO (20)	①	NO	●				HW1S-3T20	HW1S-31T20	HW1S-32T20	HW1S-33T20		
		②	NO			●							
	2NC (02)	①	NC			■		HW1S-3T02	HW1S-31T02	HW1S-32T02	HW1S-33T02		
		②	NC			■							
	2NO-2NC (22N1)	①	NO	●				HW1S-3T22N1	HW1S-31T22N1	HW1S-32T22N1	HW1S-33T22N1		
		②	NO			●							
		③	NC			■							
		④	NC			■							
	4NO (40)	①	NO	●				HW1S-3T40	HW1S-31T40	HW1S-32T40	HW1S-33T40		
		②	NO			●							
		③	NO	●									
		④	NO			●							
	4NC (04)	①	NC			■		HW1S-3T04	HW1S-31T04	HW1S-32T04	HW1S-33T04		
		②	NC			■							
		③	NC			■							
		④	NC			■							
	2NO-1NC (21N1) ★☆☆	①	NO	●				HW1S-3JT21N1	—	—	—		
		②	NO			●							
③		NC			●								
④		—	Dummy Block										



- Knob operator: white indicator on black body
- On the contact arrangement marked with ★ in the table above, the rated current (load switching current) is reduced to a half of the related current of the contact block. The rated insulation voltage and the rated thermal current remain unchanged.
- For models with ☆, contacts may overlap when the operator position is changed.
- Other contact arrangements are also available. See **B-211** to **B-213**.
- Selector switches with one or three contact blocks contain a dummy block.
- See **B-186** for gold-plated silver contacts.
- Turn the operator to each position accurately.

Contact Block Mounting Position



Key Selector Switches (Pin Tumbler Key)

Package Quantity: 1



Shape	No. of Positions	Contact	Contact Block		Operator Position			Cam Code	Maintained 1 2	
			Mounting Position	Contact	1	2				
 Pin Tumbler Key HW1K  (NC contact only)	90° 2-position	1NC (01)	①	NC	●			—	HW1K-2PA01	
			②	—	Dummy Block					
		1NO-1NC (11)	①	NO		●			—	HW1K-2PA11
			②	NC	●					
		2NC (02)	①	NC	●				—	HW1K-2PA02
			②	NC	●					
		2NO-1NC (21)	①	NO		●			—	HW1K-2PA21
			②	NO		●				
			③	NC	●					
			④	—	Dummy Block					
		3NC (03)	①	NC	●				—	HW1K-2PA03
			②	NC	●					
			③	NC	●					
			④	—	Dummy Block					
		2NO-2NC (22)	①	NO		●			—	HW1K-2PA22
			②	NC	●					
③	NO			●						
④	NC		●							



- Each selector key switch is supplied with two keys.
- 15 types of key numbers are available in addition to standard (500) key. See below for details.
- Spring-return type is also available. See below for details.
- Key retained position can be selected. See below for details.

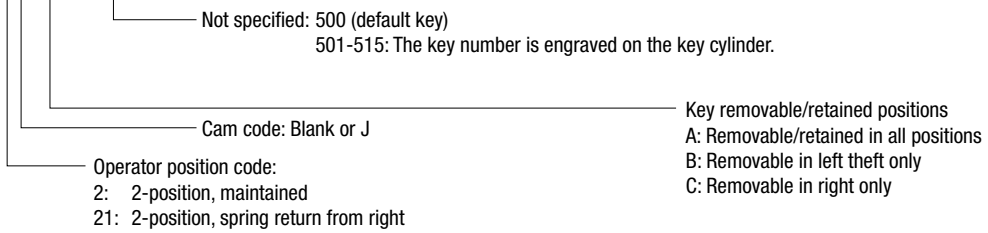

Ordering Information

Example: HW1K-2JPA01-501



Maintained (90° 2-position)		Spring Return (60° 2-position)
		
Cam code: blank	Cam code: J	Cam code: blank

Key Retained Position		
A (removable in all positions) 	B (removable in left only) 	C (removable in right only) 
Cam code: blank		

Key Retained Position		
A (removable in all positions) 	B (removable in left only) 	C (removable in right only) 
Cam code: J		

- For more contact arrangement, see B-211 to B-213.
- Key selector switches with one or three contact blocks contain a dummy block.
- See B-186 for gold-plated silver contacts.
- Turn the operator to each position accurately.

Contact Block Mounting Position



① ②: Key removal position
● ●: Key retained position

Note: The key cannot be removed in a spring return position.

- APEM
- Switches & Pilot Lights
- Control Boxes
- Emergency Stop Switches
- Enabling Switches
- Safety Products
- Explosion Proof
- Terminal Blocks
- Relays & Sockets
- Circuit Protectors
- Power Supplies
- LED Illumination
- Controllers
- Operator Interfaces
- Sensors
- AUTO-ID

- Flush Silhouette
- ø16
- ø22
- ø30
- Miniature
- Pilot Lights

- HW
- TW
- YW

Key Selector Switches (Pin Tumbler Key)

Package Quantity: 1

Shape	No. of Positions	Contact Configuration			Operator Position			Cam Code	Maintained 1 0 2	
		Contact Code	Mounting Position	Contact	1	0	2			
 Pin Tumbler Key HW1K	45° 3-position	2NC (02)	①	NC				—	HW1K-3PA02	
			②	NC						
		2NO-2NC (22N1)	①	NO					—	HW1K-3PA22N1
			②	NO						
			③	NC						
			④	NC						
		4NC (04)	①	NC					—	HW1K-3PA04
			②	NC						
			③	NC						
			④	NC						
		2NO-1NC (21N1) ★☆☆	①	NO					J	HW1K-3JPA21N1
			②	NO						
			③	NC						
			④	—	Dummy Block					
		4NC (04) ★	①	NC					S	HW1K-3SPA04
			②	NC						
③	NC									
④	NC									

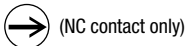

- On the contact arrangement marked with ★ in the table above, the rated current (load switching current) is reduced to a half of the related current of the contact block. The rated insulation voltage and the rated thermal current remain unchanged.
- For models with ☆, contacts may overlap when the operator is changed.
- For contact block mounting position, see the figure on the right.
- Each key selector switch is supplied with two keys.
- 15 types of key numbers are available in addition to standard (500) key. See below for details.
- Spring-return type is also available. See below for details.
- Key retained position can be selected. See table below details.

Contact Block Mounting Position



Ordering Information

Example: HW1K-3SPA04-501

Not specified: 500 (default key)

501-515: The key number is engraved on the key cylinder.

Cam code: Blank, J, or S

Operator position code:

3: 3-position, maintained

31: 3-position, spring return from right

32: 3-position, spring return from left

33: 3-position, spring return two way

Key removal/retained positions

A: Removable in all positions

B: Removable in left and center

C: Removable in right and center





D: Removable in center only

E: Removable in right and left







G: Removable in left only

H: Removable in right only

Note: The key cannot be removed in a spring return position.

Maintained (45° 3-position)	Spring Return (45° 3-position)		
Maintained 	Spring Return from Right 	Spring Return from Left 	Spring Return Two-way 
Cam code: blank, J, or S	Cam code: blank		

- For more contact arrangement, see B-211 to B-213.
- Key selector switches with one or three contact blocks contain a dummy block.
- See B-186 for gold-plated silver contacts.
- Turn the operator to each position accurately.

Key Retained Position (45° 3-position)			
A (removable in all positions) 	B (removable in left and center) 	C (removable in right and center) 	D (removable in center only) 
E (removable in right and left only) 	G (removable in left only) 	H (removable in right only) 	

① ②: Key removal position

● ① ②: Key retained position

Note: The key cannot be removed in a spring return position.

Key Selector Switches (Disc Tumbler Key)

Package Quantity: 1

No. of Positions	Disc Tumbler Key HW1K		Operator Position		Cam Code	Maintained (90°)	Spring Return from Right (60°)	
	Contact Configuration		1	2		1 2	1 2	
	Contact Code	Mounting Position	Contact					
90° 2-position/ 60° 2-position	1NO (10)	①	NO		●	—	HW1K-2A10	HW1K-21B10
		②	—	Dummy Block				
	1NC (01)	①	NC	●		—	HW1K-2A01	HW1K-21B01
		②	—	Dummy Block				
	1NO-1NC (11)	①	NO		●	—	HW1K-2A11	HW1K-21B11
		②	NC	●				
	2NO (20)	①	NO		●	—	HW1K-2A20	HW1K-21B20
		②	NO		●			
	2NC (02)	①	NC	●		—	HW1K-2A02	HW1K-21B02
		②	NC	●				
	2NO-1NC (21)	①	NO		●	—	HW1K-2A21	HW1K-21B21
		②	NO		●			
		③	NC	●				
		④	—	Dummy Block				
	3NC (03)	①	NC	●		—	HW1K-2A03	HW1K-21B03
		②	NC	●				
		③	NC	●				
		④	—	Dummy Block				
	2NO-2NC (22)	①	NO		●	—	HW1K-2A22	HW1K-21B22
		②	NC	●				
③		NO		●				
④		NC	●					



- Each key selector switch is supplied with two keys.
- 3 types of key numbers are available in addition to standard key.
- Key retained position can be selected. See table below for key retained positions.

Contact Block Mounting Position



Ordering Information

Example: HW1K-2JA01-1H

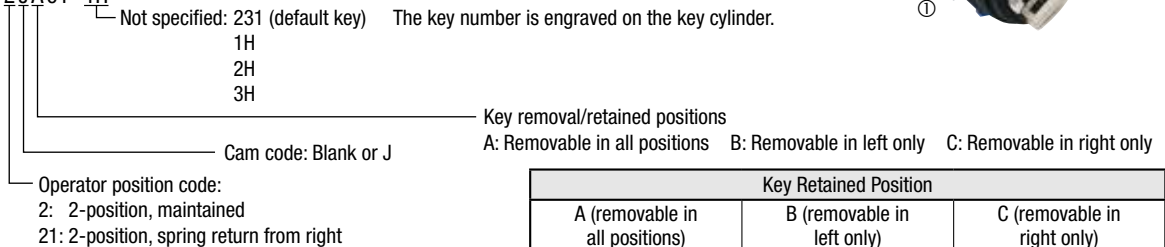

Maintained (90° 2-position)		Spring Return (60° 2-position)
		Spring Return from Right
Cam code: blank	Cam code: J	Cam code: blank

Key Retained Position		
A (removable in all positions)	B (removable in left only)	C (removable in right only)
Cam code: blank		
Key Removal Position		
A (removable in all positions)	B (removable in left only)	C (removable in right only)
Cam code: J		

- For more contact arrangement, see B-211 to B-213.
- Key selector switches with one or three contact blocks contain a dummy block.
- See B-186 for gold-plated silver contacts.
- Turn the operator to each position accurately.

① ②: Key removal position
 ① ②: Key retained position
 Note: The key cannot be removed in a spring return position.

APEM

Switches & Pilot Lights

Control Boxes

Emergency Stop Switches

Enabling Switches

Safety Products

Explosion Proof

Terminal Blocks

Relays & Sockets

Circuit Protectors

Power Supplies

LED Illumination

Controllers

Operator Interfaces

Sensors

AUTO-ID

Flush Silhouette

ø16

ø22

ø30

Miniature

Pilot Lights

HW

TW

YW

Key Selector Switches (Disc Tumbler Key)

Package Quantity: 1

No. of Positions	Disc Tumbler Key HW1K										
	Contact Configuration			Operator Position		Cam Code	Maintained	Spring Return from Right	Spring Return from Left	Spring Return Two-way	
	Contact Code	Mounting Position	Contact	1	0		2	1 0 2	1 0 2	1 0 2	1 0 2
45° 3-position	2NO (20)	①	NO	●			—	HW1K-3A20	HW1K-31B20	HW1K-32C20	HW1K-33D20
		②	NO			●					
	2NC (02)	①	NC			■	—	HW1K-3A02	HW1K-31B02	HW1K-32C02	HW1K-33D02
		②	NC	■							
	2NO-2NC (22N1)	①	NO	●			—	HW1K-3A22N1	HW1K-31B22N1	HW1K-32C22N1	HW1K-33D22N1
		②	NO			●					
		③	NC			■					
	4NO (40)	①	NO	●			—	HW1K-3A40	HW1K-31B40	HW1K-32C40	HW1K-33D40
		②	NO			●					
		③	NO	●							
		④	NO			●					
	4NC (04)	①	NC			■	—	HW1K-3A04	HW1K-31B04	HW1K-32C04	HW1K-33D04
		②	NC	■							
		③	NC			■					
		④	NC	■							
	4NC (04) ★	①	NC			●	S	HW1K-3SA04	—	—	—
②		NC	●								
③		NC			●						
④		NC	●								
2NO-1NC (21N1) ★☆☆	①	NO	●			J	HW1K-3JA21N1	—	—	—	
	②	NO			●						
	③	NC			■						
	④	—			Dummy Block						

- On the contact arrangement marked with ★ in the table above, the rated current (load switching current) is reduced to a half of the related current of the contact block. The rated insulation voltage and the rated thermal current remain unchanged.
- For models with ★, contacts may overlap when the operator is changed. Each key selector switch is supplied with two keys.
- 3 types of key numbers are available in addition to standard key.
- Key retained position can be selected. See table below for key retained positions.

Contact Block Mounting Position



Ordering Information

Example: HW1K-3SA04-1H

Not specified: 231 (default key) The key number is engraved on the key cylinder.

1H
2H
3H



Key removal/retained positions

Operator position code:

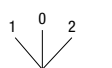

3: 3-position, maintained
 31: 3-position, spring return from right
 32: 3-position, spring return from left
 33: 3-position, spring return two way

A: Removable in all positions
 B: Removable in left and center
 C: Removable in right and center
 D: Removable in center only
 E: Removable in right and left
 G: Removable in left only
 H: Removable in right only

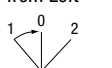
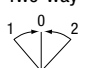
Note: The key cannot be removed in a spring return position.

Maintained (45° 3-position)	Spring Return (45° 3-position)		
Maintained	Spring Return from Right	Spring Return from Left	Spring Return Two-way
			
Cam code: blank, J, or S	Cam code: blank		

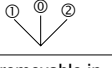
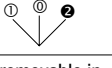
- For more contact arrangement, see B-211 to B-213.
- Key selector switches with one or three contact blocks contain a dummy block.
- See B-186 for gold-plated silver contacts.
- Turn the operator to each position accurately.

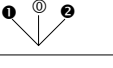
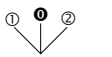
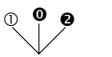
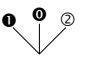
Key Retained Position			
A (removable in all positions)	B (removable in left and center)	C (removable in right and center)	D (removable in center only)
			
E (removable in right and left only)	G (removable in left only)	H (removable in right only)	
			

①②③: Key removal position

①②③: Key retained position

Note: The key cannot be removed in a spring return position.

LED Selector Switches (Knob Operator)

Package Quantity: 1

No. of Positions	Contact Configuration			Operator Position			Operating Voltage	Maintained (90°)	Spring return from right (60°)	—	—	Color Code
	Contact Code	Mounting Position	Contact	1	2							
90° 2-position/ 60° 2-position	1NO-1NC (11)			①	NO	●	24V AC/DC	HW1F-211Q4*	HW1F-2111Q4*	/	/	R G Y A S PW
				②	NC	●	100/110V AC	HW1F-211H2*	HW1F-2111H2*			
							200/220V AC	HW1F-211M2*	HW1F-2111M2*			
	2NO (20)			①	NO	●	24V AC/DC	HW1F-220Q4*	HW1F-2120Q4*			
				②	NO	●	100/110V AC	HW1F-220H2*	HW1F-2120H2*			
							200/220V AC	HW1F-220M2*	HW1F-2120M2*			
	2NO-2NC (22)			①	NO	●	24V AC/DC	HW1F-222Q4*	HW1F-2122Q4*			
				②	NC	●	100/110V AC	HW1F-222H2*	HW1F-2122H2*			
				③	NO	●	200/220V AC	HW1F-222M2*	HW1F-2122M2*			
				④	NC	●						
45° 3-position	2NO (20)			①	NO	●	24V AC/DC	HW1F-320Q4*	HW1F-3120Q4*	HW1F-3220Q4*	HW1F-3320Q4*	R G Y A S PW
				②	NO	●	100/110V AC	HW1F-320H2*	HW1F-3120H2*	HW1F-3220H2*	HW1F-3320H2*	
							200/220V AC	HW1F-320M2*	HW1F-3120M2*	HW1F-3220M2*	HW1F-3320M2*	
	2NC (02)			①	NC	●	24V AC/DC	HW1F-302Q4*	HW1F-3102Q4*	HW1F-3202Q4*	HW1F-3302Q4*	
				②	NC	●	100/110V AC	HW1F-302H2*	HW1F-3102H2*	HW1F-3202H2*	HW1F-3302H2*	
							200/220V AC	HW1F-302M2*	HW1F-3102M2*	HW1F-3202M2*	HW1F-3302M2*	
	2NO-2NC (22N1)			①	NO	●	24V AC/DC	HW1F-322N1Q4*	HW1F-3122N1Q4*	HW1F-3222N1Q4*	HW1F-3322N1Q4*	
				②	NO	●	100/110V AC	HW1F-322N1H2*	HW1F-3122N1H2*	HW1F-3222N1H2*	HW1F-3322N1H2*	
				③	NC	●	200/220V AC	HW1F-322N1M2*	HW1F-3122N1M2*	HW1F-3222N1M2*	HW1F-3322N1M2*	
				④	NC	●						
	4NO (40)			①	NO	●	24V AC/DC	HW1F-340Q4*	HW1F-3140Q4*	HW1F-3240Q4*	HW1F-3340Q4*	
				②	NO	●	100/110V AC	HW1F-340H2*	HW1F-3140H2*	HW1F-3240H2*	HW1F-3340H2*	
				③	NO	●	200/220V AC	HW1F-340M2*	HW1F-3140M2*	HW1F-3240M2*	HW1F-3340M2*	
				④	NO	●						
	4NC (04)			①	NC	●	24V AC/DC	HW1F-304Q4*	HW1F-3104Q4*	HW1F-3204Q4*	HW1F-3304Q4*	
				②	NC	●	100/110V AC	HW1F-304H2*	HW1F-3104H2*	HW1F-3204H2*	HW1F-3304H2*	
				③	NC	●	200/220V AC	HW1F-304M2*	HW1F-3104M2*	HW1F-3204M2*	HW1F-3304M2*	
				④	NC	●						

- Specify a color code in place of * in the Part No. R (red), G (green), Y (yellow), A (amber), S (blue), PW (pure white)
- See **B-186** for other operating voltage such as 6V AC/DC and 12V AC/DC.
- Illuminated selector switches of 24V AC/DC or below with 2 or 4 contact blocks have a dummy block.
- See **B-211** to **B-213** for other contact arrangements.
- See **B-186** for gold-plated silver contacts.
- Turn the operator to each position accurately.

Contact Block Mounting Position

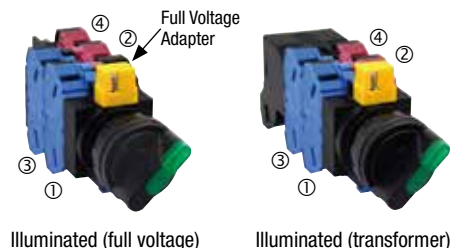

APEM

Switches & Pilot Lights

Control Boxes

Emergency Stop Switches

Enabling Switches

Safety Products

Explosion Proof

Terminal Blocks

Relays & Sockets

Circuit Protectors

Power Supplies

LED Illumination

Controllers

Operator Interfaces

Sensors

AUTO-ID

Flush Silhouette

ø16

ø22

ø30

Miniature

Pilot Lights

HW

TW

YW

ø22 HW Series Illuminated Selector Switches

LED

Selector Switches (Lever Operator)

Package Quantity: 1

No. of Positions	Lever Operator HW1F□□L		Operator Position		Operating Voltage	Maintained (90°)	Spring Return from Right (60°)			Color Code		
	Contact Code	Contact Block	1	2		1	2	—	—			
90° 2-position/ 60° 2-position	1NO-1NC (11)	① NO	●		24V AC/DC	HW1F-2L11Q4*	HW1F-21L11Q4*			R G Y A S P W		
		② NC	●		100/110V AC	HW1F-2L11H2*	HW1F-21L11H2*					
						200/220V AC	HW1F-2L11M2*				HW1F-21L11M2*	
	2NO (20)	① NO	●		24V AC/DC	HW1F-2L20Q4*	HW1F-21L20Q4*					
		② NO	●		100/110V AC	HW1F-2L20H2*	HW1F-21L20H2*					
						200/220V AC	HW1F-2L20M2*				HW1F-21L20M2*	
	2NO-2NC (22)	① NO	●		24V AC/DC	HW1F-2L22Q4*	HW1F-21L22Q4*					
		② NC	●		100/110V AC	HW1F-2L22H2*	HW1F-21L22H2*					
		③ NO	●		200/220V AC	HW1F-2L22M2*	HW1F-21L22M2*					
		④ NC	●									
	45° 3-position	2NO (20)	① NO	●		24V AC/DC	HW1F-3L20Q4*	HW1F-31L20Q4*	HW1F-32L20Q4*		HW1F-33L20Q4*	R G Y A S P W
			② NO	●		100/110V AC	HW1F-3L20H2*	HW1F-31L20H2*	HW1F-32L20H2*		HW1F-33L20H2*	
					200/220V AC	HW1F-3L20M2*	HW1F-31L20M2*	HW1F-32L20M2*	HW1F-33L20M2*			
2NC (02)		① NC		●	24V AC/DC	HW1F-3L02Q4*	HW1F-31L02Q4*	HW1F-32L02Q4*	HW1F-33L02Q4*			
		② NC		●	100/110V AC	HW1F-3L02H2*	HW1F-31L02H2*	HW1F-32L02H2*	HW1F-33L02H2*			
						200/220V AC	HW1F-3L02M2*	HW1F-31L02M2*	HW1F-32L02M2*	HW1F-33L02M2*		
2NO-2NC (22N1)		① NO	●		24V AC/DC	HW1F-3L22N1Q4*	HW1F-31L22N1Q4*	HW1F-32L22N1Q4*	HW1F-33L22N1Q4*			
		② NO	●		100/110V AC	HW1F-3L22N1H2*	HW1F-31L22N1H2*	HW1F-32L22N1H2*	HW1F-33L22N1H2*			
		③ NC		●	200/220V AC	HW1F-3L22N1M2*	HW1F-31L22N1M2*	HW1F-32L22N1M2*	HW1F-33L22N1M2*			
		④ NC		●								
4NO (40)		① NO	●		24V AC/DC	HW1F-3L40Q4*	HW1F-31L40Q4*	HW1F-32L40Q4*	HW1F-33L40Q4*			
		② NO	●		100/110V AC	HW1F-3L40H2*	HW1F-31L40H2*	HW1F-32L40H2*	HW1F-33L40H2*			
		③ NO	●		200/220V AC	HW1F-3L40M2*	HW1F-31L40M2*	HW1F-32L40M2*	HW1F-33L40M2*			
		④ NO	●									
4NC (04)		① NC		●	24V AC/DC	HW1F-3L04Q4*	HW1F-31L04Q4*	HW1F-32L04Q4*	HW1F-33L04Q4*			
		② NC		●	100/110V AC	HW1F-3L04H2*	HW1F-31L04H2*	HW1F-32L04H2*	HW1F-33L04H2*			
		③ NC		●	200/220V AC	HW1F-3L04M2*	HW1F-31L04M2*	HW1F-32L04M2*	HW1F-33L04M2*			
		④ NC		●								

- TW • Specify a color code in place of * in the Part No. R (red), G (green), Y (yellow), A (amber), S (blue), PW (pure white)
- YW • See **B-186** for other operating voltage such as 6V AC/DC, 12V AC/DC, and 110V DC.
- Illuminated selector switches of 24V AC/DC or below with 2 or 4 contact blocks have a dummy block.
- See **B-211** to **B-213** for other contact arrangements.
- See **B-186** for gold-plated silver contacts.
- Turn the operator to each position accurately.

Contact Block Mounting Position

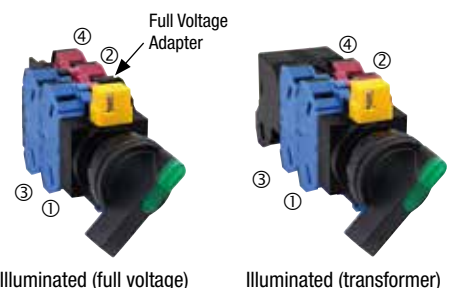

Illuminated (full voltage)

Illuminated (transformer)

APEM

Switches & Pilot Lights

Control Boxes

Emergency Stop Switches

Enabling Switches

Safety Products

Explosion Proof

Terminal Blocks

Relays & Sockets

Circuit Protectors

Power Supplies

LED Illumination

Controllers

Operator Interfaces

Sensors

AUTO-ID

Flush Silhouette

ø16

ø22

ø30

Miniature

Pilot Lights

HW

TW

YW

Dimensions

All dimensions in mm.

Selector Switch (Knob Operator)

Terminal Screws M3.5 Integrated Terminal Cover

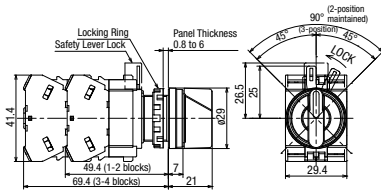

Key Selector Switch (Knob Operator)
Disc Tumbler Type

Terminal Screws M3.5 Integrated Terminal Cover
Pin Tumbler Type

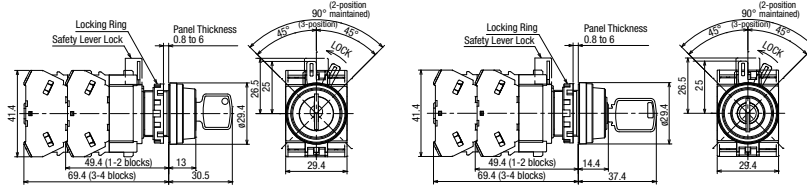

Illuminated Selector Switch (Knob Operator)

Terminal Screws M3.5 Integrated Terminal Cover

6, 12, 24V AC/DC, Without LED lamp

100/110V AC, 200/220V AC (240V AC maximum)

110V DC, 380V AC minimum

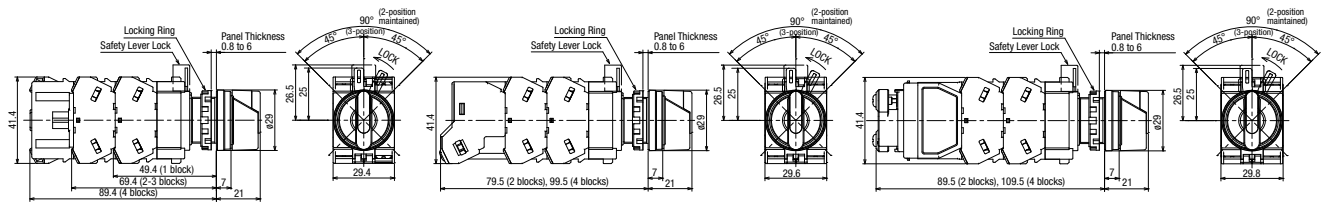

Illuminated Selector Switch (Lever Operator)

Terminal Screws M3.5 Integrated Terminal Cover

6, 12, 24V AC/DC, Without LED lamp

100/110V AC, 200/220V AC (240V AC maximum)

110V DC, 380V AC minimum

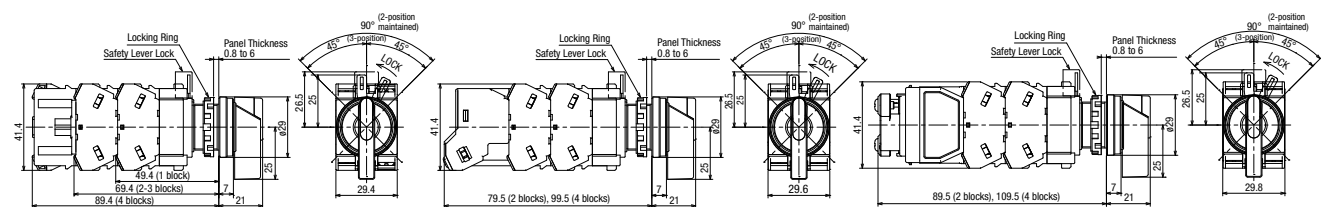

Bottom View

Non-illuminated

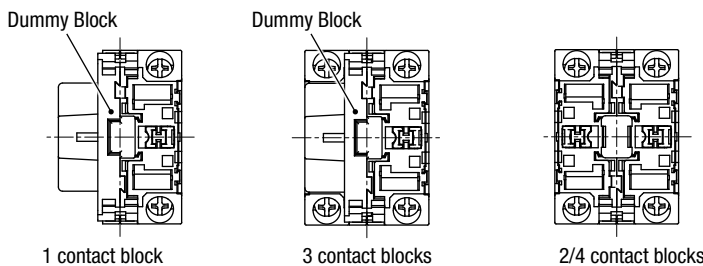

Illuminated

6, 12, 24V AC/DC, Without LED lamp

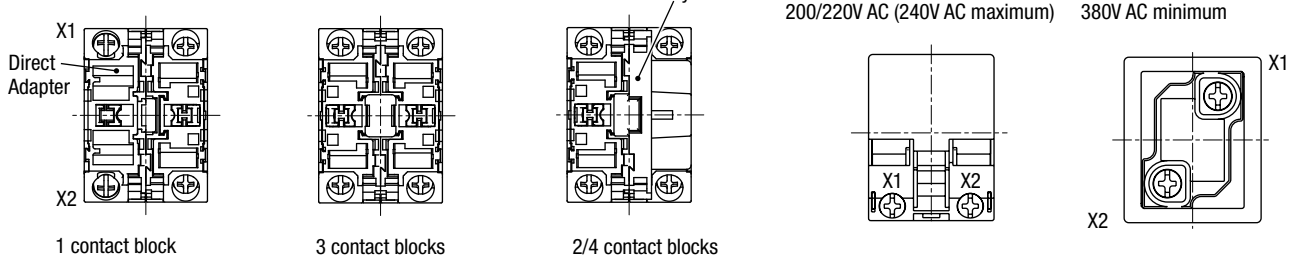

• For DC-DC Converter types, terminal X1 is ⊕, X2 is ⊖.

ø22 HW Series Selector Switch Contact Arrangement Chart

Selector Switch Contact Arrangement

90° 2-position (Spring Return 60° 2-position) <Maintained/Spring Return from Right>

Contact Code	Contact Block		Operator Operation and Circuit Availability						Cam Code	
			Maintained			Spring Return from Right				
	Mounting Position	Contact	Knob/ Lever	Key	Illuminated	Knob/ Lever	Key	Illuminated		
			Operator Position		Operator Position					
1	2	1	2	1	2	1	2			
1NO (10)	①	NO		●				●		—
	②	—	Dummy Block			Dummy Block				
1NC (01)	①	NC	●				●			—
	②	—	Dummy Block			Dummy Block				
1NO-1NC (11)	①	NO		●				●		—
	②	NC	●				●			
Terminal Blocks	①	NO		●				●		—
	②	NO		●				●		
Relays & Sockets	①	NC	●				●			—
	②	NC	●				●			
Power Supplies	①	NO		●				●		—
	②	NC	●				●			
	③	NO		●				●		
	④	NC	●				●			
Controllers	①	NC	●				●			—
	②	NO		●				●		
	③	NO		●				●		
	④	NO		●				●		
Sensors	①	NO		●				●		—
	②	NO		●				●		
	③	NO		●				●		
	④	NO		●				●		
1NO-1NC ★ (7S)	①	EM	—————			—————				—
	②	LB	—————			—————				
Flush Silhouette ø16	①	NC	●				●			—
	②	NC	●				●			
	③	NC	●				●			
	④	—	Dummy Block			Dummy Block				
ø22	①	NO		●				●		—
	②	NC	●				●			
	③	NO		●				●		
	④	—	Dummy Block			Dummy Block				
ø30	①	NO		●				●		—
	②	NC	●				●			
	③	NO		●				●		
	④	—	Dummy Block			Dummy Block				
Miniature	①	NO		●				●		—
	②	NC	●				●			
	③	NO		●				●		
	④	—	Dummy Block			Dummy Block				

90° 2-position Cam Reversed (Maintained)

Contact Code	Contact Block		Operator Operation and Circuit Availability		Cam Code
			Maintained		
	Mounting Position	Contact	Knob/Key/Illuminated		
			Operator Position		
2	1	2	1		
2NC (02)	①	NC		●	J
	②	NC		●	
3NC (03)	①	NC		●	J
	②	NC		●	
	③	NC		●	
	④	—	Dummy Block		

- On the contact arrangement marked with ★ in the table above, the rated current (load switching current) is reduced to a half of the related current of the contact block. The rated insulation voltage and the rated thermal current remain unchanged.

45° 3-position

<Maintained>

Contact Code	Contact Block		Operator Position			Circuit Availability			Cam Code
	Mounting Position	Contact	1 	0 	2 	Knob/ Lever	Key	Illuminated	
1NO-1NC ★ (11N1) ☆	①	NC		●		×	×	×	J
	②	NO			●				
4NC (04) ★	①	NC			●				S
	②	NC	●			×	×	×	
	③	NC			●				
	④	NC	●						
2NO-1NC ★ (21N1) ☆	①	NO	●						J
	②	NO			●	×	×	×	
	③	NC		●					
	④	—	Dummy Block						

45° 3-position

<Maintained/Spring Return from Right/Spring Return from Left/Spring Return Two-way>

Contact Code	Contact Block		Operator Position			Circuit Availability			Cam Code
	Mounting Position	Contact	1 	0 	2 	Knob/ Lever	Key	Illuminated	
1NO-1NC (11)	①	NO	●						—
	②	NC	■			×	×	×	
1NO-1NC (11N1)	①	NC		■		×	×	×	—
	②	NO			●				
2NO (20)	①	NO	●			×	×	×	—
	②	NO			●				
2NC (02)	①	NC		■		×	×	×	—
	②	NC	■						
2NO-2NC (22N1)	①	NO	●						—
	②	NO			●	×	×	×	
	③	NC		■					
	④	NC	■						
2NO-2NC (22N2)	①	NC		■					—
	②	NO			●	×	×	×	
	③	NC		■					
	④	NO			●				
4NO (40)	①	NO	●						—
	②	NO			●	×	×	×	
	③	NO	●						
	④	NO			●				
4NC (04)	①	NC		■					—
	②	NC	■			×	×	×	
	③	NC		■					
	④	NC	■						

- On the contact arrangement marked with ★ in the table above, the rated current (load switching current) is reduced to a half of the related current of the contact block. The rated insulation voltage and the rated thermal current remain unchanged.
- For models with ☆, contacts may overlap when the operator is changed.

APEM

Switches & Pilot Lights

Control Boxes

Emergency Stop Switches

Enabling Switches

Safety Products

Explosion Proof

Terminal Blocks

Relays & Sockets

Circuit Protectors

Power Supplies

LED Illumination

Controllers

Operator Interfaces

Sensors

AUTO-ID

Flush Silhouette

ø16

ø22

ø30

Miniature

Pilot Lights

HW

TW

YW



ø22 HW Series Selector Switch Contact Arrangement Chart

45° 4-position

Contact Code	Contact Block		Operator Position				Maintained	Cam Code
			1	2	3	4	1 2 3 4 Knob Operator	
APEM Switches & Pilot Lights Control Boxes Emergency Stop Switches Enabling Switches Safety Products Explosion Proof Terminal Blocks Relays & Sockets Circuit Protectors Power Supplies LED Illumination Controllers Operator Interfaces Sensors AUTO-ID Flush Silhouette	★ ☆ 1NO-2NC (12)	① NO	●				×	—
		② NC		●				
		③ NC			●			
		④ —	Dummy Block					
Control Boxes Emergency Stop Switches Enabling Switches Safety Products Explosion Proof Terminal Blocks Relays & Sockets Circuit Protectors Power Supplies LED Illumination Controllers Operator Interfaces Sensors AUTO-ID Flush Silhouette	1NO-3NC (13N6)	① LB		■			×	—
		② NC		●				
		③ NC			●			
		④ NO				●		
Control Boxes Emergency Stop Switches Enabling Switches Safety Products Explosion Proof Terminal Blocks Relays & Sockets Circuit Protectors Power Supplies LED Illumination Controllers Operator Interfaces Sensors AUTO-ID Flush Silhouette	★ ☆ 2NO-2NC (22N3)	① NO	●				×	—
		② NC		●				
		③ NC			●			
		④ NO				●		

30° 5-position

Contact Code	Contact Block		Operator Position					Maintained	Cam Code
			1	2	3	4	5	1 2 3 4 5 Knob Operator	
Control Boxes Emergency Stop Switches Enabling Switches Safety Products Explosion Proof Terminal Blocks Relays & Sockets Circuit Protectors Power Supplies LED Illumination Controllers Operator Interfaces Sensors AUTO-ID Flush Silhouette	★ ☆ 2NO-2NC (22N3)	① NO	●					×	—
		② NC		●					
		③ NC				●			
		④ NO					●		

- On the contact arrangement marked with ★ in the table above, the rated current (load switching current) is reduced to a half of the related current of the contact block. The rated insulation voltage and the rated thermal current remain unchanged.
- For models with ☆, contacts may overlap when the operator is changed.

Part No. Development

Example 1: Knob Operator 2-position

HW1S - 2 T 11

- HW1S - Contact code
- T - "T" for knob operator
- 2 - No. of position/Operator Position
- 11 - 2-position/maintained
- 21: 2-position/spring return from right
- 22: 2-position/spring return from left

Example 2: Key Selector 3-position

HW1K - 3 J P A 22N1

- HW1K - Contact code
- 3 - Key removal option code
- J - Key Type
- P - Blank: disc tumbler
- A - Pin tumbler
- 22N1 - Cam Code
- No. of position/Operator Position
- 3: 3-position/maintained
- 31: 3-position/spring return from right
- 32: 3-position/spring return from left
- 33: 3-position/spring return two-way

Example 3: Illuminated Selector 3-position

HW1F - 33 L 22N2 H2 R

- HW1F - Color code (see B-208 to B-209)
- 33 - Operating voltage (see B-186)
- L - Contact code (2NO2NC)
- H2 - Operator shape: L (lever operator)
- R - No. of position/Operator Position
- 3: 3-position/maintained
- 31: 3-position/spring return from right
- 32: 3-position/spring return from left
- 33: 3-position/spring return two-way

Contact Block Mounting Position



Illuminated Selector (Full Voltage)



Illuminated Selector (Transformer)



Non-illuminated Selector

Pushbutton Selectors

Package Quantity: 1

Shape	Circuit Category	Contact Code	Contact Block		Normal		Depressed		Ring Operator		Button Color Code		
			Mounting Position	Contact	Normal	Depressed	Normal	Depressed	Part No.				
	A	1NO-1NC (11)	①	NO		●		●			HW1R-2A11*		
			②	NC	●						HW1R-2A20*		
		2NO (20)	①	NO		●		■	●				
			②	NO			●						
		2NO-2NC (22)	①	NO		●			●			HW1R-2A22*	
			②	NC	●								
	③		NO		●			●					
	D	2NO (20)	①	NO		●		■	●			HW1R-2D20*	
			②	NO					●				
		2NO-2NC (22N1)	①	NO		●			●			HW1R-2D22N1*	
			②	NO						●			
	E	2NO-2NC (22N1)	★	①	NO		●					HW1R-2E22N1*	
				②	NO					●			
				③	NC					■			
				④	NC	■							
	F	2NO-2NC (22N1)	★ ☆	①	NO					●		HW1R-2F22N1*	
				②	NO		●						
				③	NC				●				
				④	NC	●							
	N	2NO-2NC (22N2)	★ ☆	①	NC				●			HW1R-2N22N2*	
				②	NO		●			●			
				③	NC				●				
				④	NO		●			●			
	T	2NO-2NC (22N1)		①	NO		●	●			Blocked	HW1R-2T22N1*	
②				NO		●	●						
③				NC	●								
④				NC	●								

B
G
R
Y
S
W

- Specify a button color code in place of * in the Part No. B (black), G (green), R (red), Y (yellow), S (blue), W (white)
- When operating the pushbutton selector, do not turn the operator ring or the lock lever while the button is depressed. Otherwise the pushbutton selector may be damaged.
- On the contact arrangement marked page with ★ in the table above, the rated current (load switching current) is reduced to a half of the related current of the contact block. The rated insulation voltage and the rated thermal current remain unchanged.
- For models with ☆, contacts may overlap when the operator is changed.

Dimensions

All dimensions in mm.

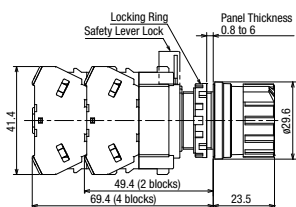

Terminal Screws M3.5

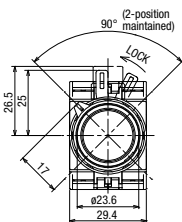

Integrated Terminal Cover

• See B-210 for the bottom view.

Contact Block Mounting Position

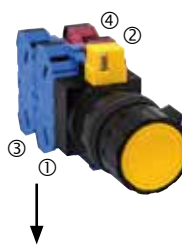

Mounting Position	Contact	Left		Right	
		Normal	Push	Normal	Push
①	NO				●
②	NO		●		
③	NC			●	
④	NC	●			

APEM

Switches & Pilot Lights

Control Boxes

Emergency Stop Switches

Enabling Switches

Safety Products

Explosion Proof

Terminal Blocks

Relays & Sockets

Circuit Protectors

Power Supplies

LED Illumination

Controllers

Operator Interfaces

Sensors

AUTO-ID

Flush Silhouette

ø16

ø22

ø30

Miniature

Pilot Lights



HW

TW

YW

Mono-Lever Switches

Package Quantity: 1

Shape	Positions	Part No. (Ordering No.)
HW1M Standard Lever 	2-position	HW1M-1010-20
		HW1M-2020-20
		HW1M-0101-20
		HW1M-0202-20
	4-position	HW1M-0101-40
		HW1M-0202-40
HW1M-L Interlocking Lever 	2-position	HW1M-1111-22N9
		HW1M-2222-22N9
		HW1M-L1010-20
		HW1M-L2020-20
	4-position	HW1M-L0101-20
		HW1M-L0202-20
		HW1M-L0101-40
		HW1M-L0202-40
4-position	HW1M-L1111-22N9	
	HW1M-L2222-22N9	

• On all mono-lever switches, the rated current (load switching current) is reduced to a half of the rated current of the contact block.
The rated insulation voltage and the rated thermal current remain unchanged.

Contact Arrangement Chart

2-position (Right/Left)

Contact Code	Contact Block		Lever Operator Position		
	Mounting Position	Contact	Left	Center	Right
20	①	NO	●		
	②	NO			●
40	①	NO	●		
	②	NO			●
	③	NO	●		
	④	NO			●

2-position (Up/Down)

Contact Code	Contact Block		Lever Operator Position		
	Mounting Position	Contact	Left	Center	Right
20	①	NO	●		
	②	NO			●
40	①	NO	●		
	②	NO			●
	③	NO	●		
	④	NO			●

4-position

Contact Code	Contact Block		Lever Operator Position				
	Mounting Position	Contact	Down	Left	Center	Up	Right
22N9	①	NC					●
	②	NC	●				
	③	NO		●			
	④	NO				●	

Part No. Development

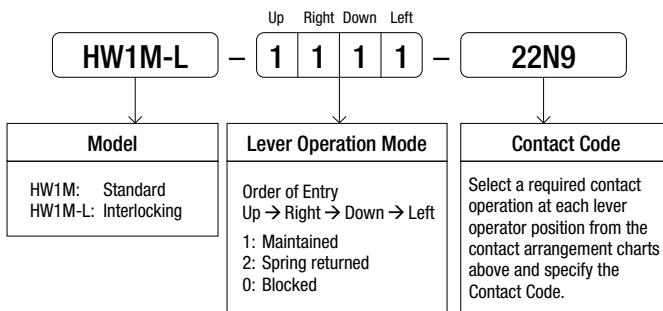

Contact Block Mounting Position and Lever Operation Position

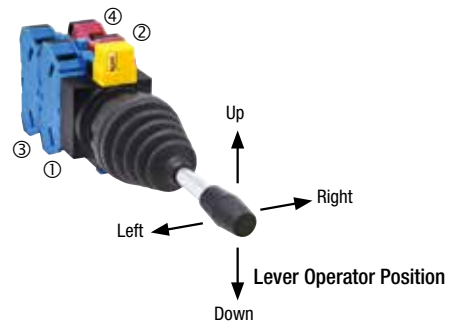

• The lever operator of the interlocking type HW1M-L is locked only in the center position.
Pull on the interlocking lever before operating the lever up/down/right/left.

Dimensions

Standard Lever

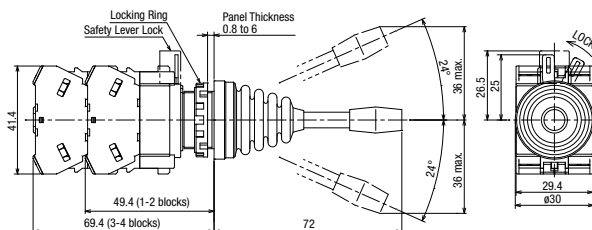

Interlocking Lever

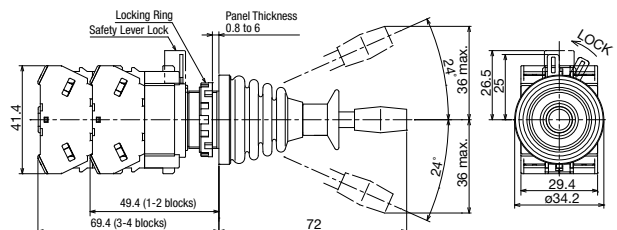

All dimensions in mm.

Terminal Screws M3.5 Integrated Terminal Cover
• See B-210 for the bottom view.

APEM

Switches & Pilot Lights

Control Boxes

Emergency Stop Switches

Enabling Switches

Safety Products

Explosion Proof

Terminal Blocks

Relays & Sockets

Circuit Protectors

Power Supplies

LED Illumination

Controllers

Operator Interfaces

Sensors

AUTO-ID

Flush Silhouette

ø16

ø22

ø30

Miniature

Pilot Lights

HW

TW

YW

Nameplates

Package Quantity: 1

Description	Legend	Material	Part No.	Ordering No.	Package Quantity	Dimensions (mm)
HWAM	Order marking plate (round) separately.	Plastic (black)	HWAM	HWAM	1	
				HWAMPN10	10	
HWAQ	Order marking plate (square) separately.	Plastic (black)	HWAQ	HWAQ	1	
				HWAQPN10	10	
HWAS	Blank	Plastic (black)	HWAS-0	HWAS-0	1	
				HWAS-0PN10	10	

- Nameplates cannot be used on HW series control stations (HW1X).

Marking Plates for HWAM/HWAQ

Description	Material	Part No.	Ordering No.	Package Quantity	Dimensions (mm)
HWNP	Aluminum (black) Thickness = 1.0mm	HWNP-□	HWNP-□	1	White legend on black background. Engraving area: W25×H7
			HWNP-□PN10	10	

- Specify a legend code in place of □ in the Ordering No.

Legends

Code	Legend
0	(blank)
1	ON
2	OFF
3	START
4	STOP
31	OFF-ON
35	HAND-AUTO
53	HAND-OFF-AUTO











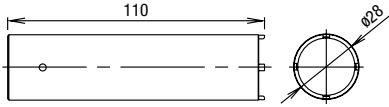

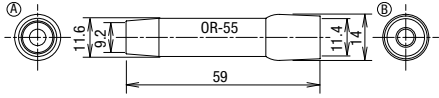
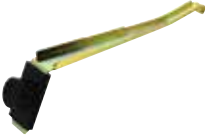
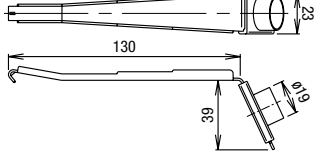
- See **B-226** for how to install nameplates/markings plates, and how to remove marking plates.

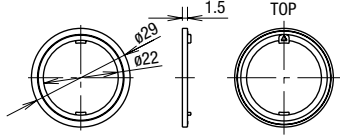

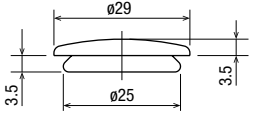
Accessories

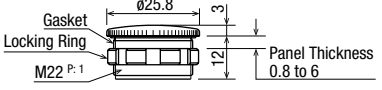
All dimensions in mm.

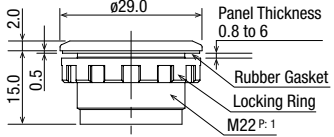
When ordering, specify the Ordering No.

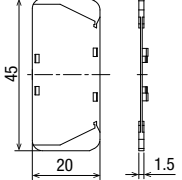
Shape	Material	Part No.	Ordering No.	Package Quantity	Dimensions (mm)	
Tool	 <p>Locking Ring Wrench</p>	Metal (brass) (weight: approx. 150g)	MW9Z-T1	MW9Z-T1	1	<ul style="list-style-type: none"> Used to tighten the locking ring when installing the HW switch onto a panel. 
	 <p>Lamp Holder Tool</p>	Nitrile rubber (black)	OR-55	OR-55	1	<ul style="list-style-type: none"> Used to install and remove the LED lamps. See B-223 to B-224 for how to install. Ⓐ : BA9S 
	 <p>Contact Block Removal Tool</p>	Zinc-plated metal Nitril rubber	TW-KC1	TW-KC1	1	<ul style="list-style-type: none"> Used to remove the contact block and transformer, and also to install/remove the pilot light and illuminated pushbutton lens. See B-224. 
 <p>Anti-rotation Ring</p>	Ring: polyamide Gasket: nitril rubber	HW9Z-RL	HW9Z-RLPN10	10	<ul style="list-style-type: none"> Used to prevent the operator from turning. Generally used when using no nameplates on selector switches and pushbutton selectors. 	
 <p>Rubber Mounting Hole Plug</p>	Nitril rubber (black)	OB-31	OB-31PN05	5	<ul style="list-style-type: none"> Used to plug the unused ø22.2 mm mounting holes. Degree of protection: IP65 (round hole) IP40 (with anti-rotation function) 	
 <p>Rubber Mounting Hole Plug</p>	Plug: chrome-plated zinc diecast Locking ring: polyamide Gasket: nitril rubber	LW9Z-BM	LW9Z-BM	1	<ul style="list-style-type: none"> Used to plug the unused ø22.2 mm mounting holes. Degree of protection: IP66 (round hole) IP40 (with anti-rotation function) Tightening torque: 1.2 N·m 	
 <p>Metallic Mounting Hole Plug</p>	Polyamide	LW9Z-BP1	LW9Z-BP1	1	<ul style="list-style-type: none"> Used to plug the unused ø22.2 mm mounting holes. Degree of protection: IP65 Tightening torque: 2.0 N·m 	
 <p>Barrier</p>	Polyamide	HW-VU1	HW-VU1PN10	10	<ul style="list-style-type: none"> Used to prevent contact between adjacent lead wires when units are mounted closely (see B-227 for details). Barriers should always be used in close mounting. 	

APEM

Switches & Pilot Lights

Control Boxes

Emergency Stop Switches

Enabling Switches

Safety Products

Explosion Proof

Terminal Blocks

Relays & Sockets

Circuit Protectors

Power Supplies

LED Illumination

Controllers

Operator Interfaces

Sensors

AUTO-ID

Flush Silhouette

ø16

ø22

ø30

Miniature

Pilot Lights

HW









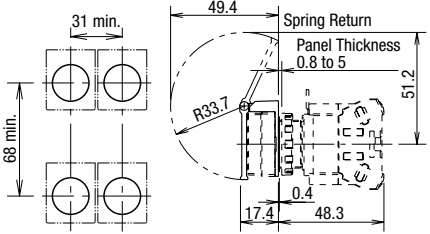

TW

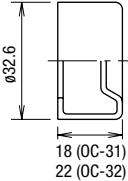
YW

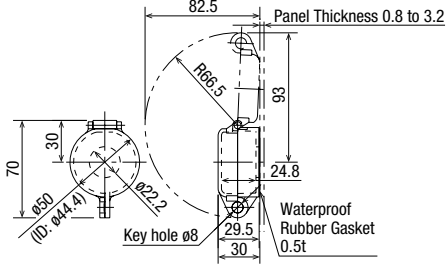
Accessories

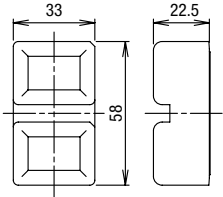
All dimensions in mm.





When ordering, specify the Ordering No.

Shape	Material	Part No.	Ordering No.	Package Quantity	Dimensions (mm)
	Spring Return	HW9Z-K1	HW9Z-K1	1	<ul style="list-style-type: none"> Used to prevent inadvertent operation for flush pushbuttons and illuminated pushbuttons. IP65 Maintained type stops at 90° and 180°. 
	Maintained	HW9Z-K11	HW9Z-K11	1	
	For flush pushbuttons	OC-31	OC-31	1	<ul style="list-style-type: none"> Used to cover and protect pushbuttons where units are subject to watersplash. Not suitable for outdoor use or where the units are subject to oil splash. Cannot be used with nameplates HWAM, HWAQ, HWAS, or HWAU. 
	For extended pushbuttons	OC-32	OC-32	1	
	Polyarylate (gasket: nitril rubber)	HW9Z-KL1	HW9Z-KL1	1	<ul style="list-style-type: none"> Used to protect pushbuttons, illuminated pushbuttons, selector switches, and key selector switches. 
	Clear Silicon Rubber	HW9Z-D7D	HW9Z-D7D	1	<ul style="list-style-type: none"> IP65 
	Nitril rubber	HW9Z-A25	HW9Z-A25PN05	5	<ul style="list-style-type: none"> Used to install the HW series units into ø25 mm mounting holes. IP65 Cannot be used with anti-rotation, nameplate, and rubber boot for dual pushbutton switches. Mounting panel thickness: 1.2 to 6.0 mm See B-225 for details.
	Gasket: polyamide Washer: metal (brass)	HW9Z-A30	HW9Z-A30PN02	2	<ul style="list-style-type: none"> Used to install the HW series units (round type) into ø30 mm mounting holes (except for HW1E, HW1B-M5/V5, and HW7D). IP65 Cannot be used with anti-rotation ring, nameplate, full-shroud illuminated pushbuttons, pushbutton selectors, and mono-lever switches. Mounting panel thickness: 1.6 to 4.0 mm
	Gasket: rubber Washer: metal	HW9Z-A30E	HW9Z-A30EPN02	2	<ul style="list-style-type: none"> Used to install jumbo dome pilot light HW1P-5Q units into ø30 mm mounting holes. IP65

Maintenance Parts

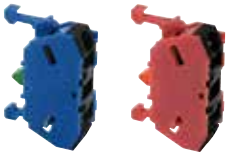

All dimensions in mm.

When ordering, specify the Ordering No.

Shape	Material	Part No.	Ordering No.	Package Quantity	Remarks
 Contact Block HW-U Weight: 11g (approx.)	NO contact	HW-U10	HW-U10	1	<ul style="list-style-type: none"> Housing color: blue/Push rod color: green MAU has gold contacts
		HW-U10-MAU	HW-U10-MAU		
	NC contact	HW-U01	HW-U01	1	<ul style="list-style-type: none"> Housing color: reddish purple/Push rod color: red MAU has gold contacts
		HW-U01-MAU	HW-U01-MAU		
	EM (early make) contact	HW-U10R	HW-U10R	1	<ul style="list-style-type: none"> Housing color: blue/Push rod color: black MAU has gold contacts
		HW-U10R-MAU	HW-U10R-MAU		
LB (late break) contact	HW-U01R	HW-U01R	1	<ul style="list-style-type: none"> Housing color: reddish purple/Push rod color: white MAU has gold contacts 	
	HW-U01R-MAU	HW-U01R-MAU			
 Dummy Block Weight: 3.5g (approx.)	Polyamide	HW-DB	HW-DBPN10	10	<ul style="list-style-type: none"> For HW-U contact blocks Used when the number of contact blocks and full voltage adapters is odd number.
 Full Voltage Adapter for Illuminated (*1) Weight: 12g (approx.)	Polyamide	HW-GA1N	HW-GA1NPN02	2	<ul style="list-style-type: none"> Applicable model: Illuminated pushbuttons Illuminated selector switches Applicable load (LED lamp) LSRD-6, LSTD-6 (6V AC/DC) LSRD-1, LSTD-1 (12V AC/DC) LSRD-2, LSTD-2 (24V AC/DC)
 Transformer Unit (*1) Weight: 12g (approx.)	100/110V AC	HW-T16	HW-T16	1	<ul style="list-style-type: none"> Applicable model: Illuminated pushbuttons Illuminated selector switches Applicable load (LED lamp) LSRD-6, LSTD-6 (6V AC/DC)
	200/220V AC	HW-T26	HW-T26	1	

*1) Maintenance parts are used for maintenance parts only. Do not use these parts for expansion or remodeling purpose.

When ordering, specify the Ordering No.

Shape	Material/Dimensions	Part No.	Ordering No.	Package Quantity	Color Code *	
 Lens	① Round flush	Polyarylate ø23.5 H4.2	HW9Z-L11*-K	HW9Z-L11*-KPN05	5	R (red), G (green), Y (yellow), A (amber), C (clear), S (blue) (*2)
	② Square flush	Polyarylate ø24.6 H4	HW9Z-L21*-K	HW9Z-L21*-KPN05	5	
	③ Round extended	Polyarylate ø23.3 H10	HW9Z-L12*-K	HW9Z-L12*-KPN05	5	
	④ ø29 mushroom	AS, marking type ø29 H12.7	ALW31LD*-K	ALW31LD*-KPN02	2	R (red), G (green), Y (yellow), A (amber), S (blue), C (clear) (*2)
	⑤ ø40 mushroom	AS, marking type ø40 H12.7	ALW41LD*-K	ALW41LD*-K	1	R (red), G (green), Y (yellow), A (amber), S (blue), C (clear) (*2)
	⑥ Jumbo dome	Polycarbonate ø66 H50	HW1A-P5*	HW1A-P5*	1	R (red), G (green), Y (yellow), A (amber), W (white), S (blue)
	⑦ Dome for pilot light	AS ø23.5 H15.1	HW1A-P2*-K	HW1A-P2*-KPN05	5	R (red), G (green), Y (yellow), A (amber), W (white), S (blue) (*3)
 Button	① Round flush with round or square bezel	Polyacetal ø23.6 H3	HW1A-B1*	HW1A-B1*PN05	5	Use ① for pushbutton selectors. B (black), G (green), R (red), Y (yellow), S (blue), W (white)
	② Round extended with round or square bezel	Polyacetal ø23.6 H9.2	HW1A-B2*	HW1A-B2*PN05	5	
	③ Square flush	Polyacetal □24.8 H3	HW2A-B1*	HW2A-B1*PN05	5	
	④ Square extended	Polyacetal □24.5 H9.2	HW2A-B2*	HW2A-B2*PN05	5	
	⑤ ø29 mushroom	Polyacetal ø29 H12.7(M18P1.0)	HW1A-B3*	HW1A-B3*PN02	2	
	⑥ ø40 mushroom	Polyacetal ø40 H12.7(M18P1.0)	HW1A-B4*	HW1A-B4*PN02	2	

*2) Use C (clear) lens for PW (pure white) illumination.

*3) Use W (white) lens for PW (pure white) illumination.

APEM

Switches & Pilot Lights

Control Boxes

Emergency Stop Switches

Enabling Switches

Safety Products

Explosion Proof

Terminal Blocks

Relays & Sockets

Circuit Protectors

Power Supplies

LED Illumination

Controllers

Operator Interfaces

Sensors

AUTO-ID

Flush Silhouette

ø16

ø22

ø30

Miniature

Pilot Lights

HW















TW

YW

Maintenance Parts

All dimensions in mm.

When ordering, specify the Ordering No.

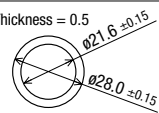
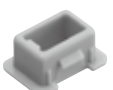
Shape		Material/Dimensions	Part No.	Ordering No.	Package Quantity	Remarks
Marking Plate	Round flush 	Acrylic ø21.5 Thickness = 1	HW9Z-P11	HW9Z-P11PN05	5	<ul style="list-style-type: none"> • White • See B-225 for dimensions and engraving area.
	Round extended 	Acrylic ø21.3 Thickness = 6.5	HW9Z-P12	HW9Z-P12PN05	5	
	Square flush 	Acrylic 22.7 Thickness = 1	HW9Z-P21	HW9Z-P21PN05	5	
	ø29/40 mm mushroom 	Acrylic ø15.7 H3.4	ALW3B	ALW3BPN05	5	
Operator Knob for Illuminated Selector Switch 	AS resin		HW9Z-FDY*-K	HW9Z-FDY*-K	1	<ul style="list-style-type: none"> • Specify a color code in place of *. R (red), G (green), Y (yellow), A (amber), W (white), S (blue) • Use W (white) knob/lever for pure white illumination.
Operator Lever for Illuminated Selector Switch 			HW9Z-FDL*-K	HW9Z-FDL*-K	1	
Spare Key (Disc Tumber Key) 	Metal (nickel-plated brass)		HW9Z-SK-231	HW9Z-SK-231PN02	2	
Spare Key (Pin Tumber Key) 	Metal (nickel-plated brass)		LW9Z-SK-500	LW9Z-SK-500PN02	2	• Standard key number
			LW9Z-SK-□	LW9Z-SK-□PN02		• Key number □ : 501 to 503
			LW9Z-SK-□	LW9Z-SK-□PN02		• Key number □ : 504 to 515
Lockig Ring 	Polyamide (black) ø28.4 H5 M22P1		HW9Z-LN	HW9Z-LNPN05	5	
Cap for Mono-lever Switch 	Standard	Nitril rubber ø10 L20	HW9Z-CPM	HW9Z-CPM	1	
Boot for Mono-lever Switch 	Standard	Nitril rubber ø29.2 L34.4	HW9Z-BLM	HW9Z-BLM	1	
Diffusing Lens 		Polycarbonate ø22.2 H21	HW9Z-PP5C	HW9Z-PP5C	1	• Used for LED type jumbo dome pilot lights only. Do not use for incandescent lamp illumination.
Safety Lever Lock 		Polyacetal (yellow)	HW9Z-LS	HW9Z-LSPN10	10	• A safety lever lock is supplied with a standard HW series switch/pilot light.
Gasket 		Nitril rubber (black)	HW9Z-WM	HW9Z-WMPN10	10	 <p>Thickness = 0.5 ø21.6 ±0.15 ø28.0 ±0.15</p>
Contact Block Plug 		Polyamide	HW9Z-CBPL	HW9Z-CBPLPN10	10	• Used to plug the hole in the center of contact block.



Maintenance Parts

All dimensions in mm.

LEDs

Except HW Jumbo Dome Pilot Lights and Dual Pushbuttons (with pilot light)

When ordering, specify the Ordering No.

Shape/Dimensions	Operating Voltage	Current Draw		Part No.	Ordering No.	Package Quantity	Base
		DC	AC				
	6V AC/DC	10mA	14mA	LSRD-6	LSRD-6	1	BA9S/13
					LSRD-6PN10	10	
	12V AC/DC	7mA	8mA	LSRD-1	LSRD-1	1	
					LSRD-1PN10	10	
	24V AC/DC	7mA	8mA	LSRD-2	LSRD-2	1	
					LSRD-2PN10	10	

- Only one color is available for LSRD so there are no codes to specify the color in the part no.
- When replacing the LED with LSRD, the lens must also be replaced (see B-219).

For HW Jumbo Dome Pilot Lights

Package Quantity: 1

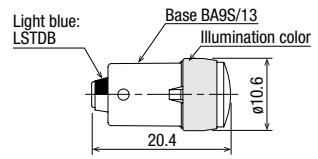
Shape	Operating Voltage	Current Draw		Ordering No.	Dimensions
		DC	AC		
	24V AC/DC	15mA	15mA	LSTDB-2*	

- Specify a color code in place of *. R (red), G (green), A (amber), W (white), S (blue), PW (pure white)
- Use a PW (pure white) LED lamp for Y (yellow) illumination.

For HW7D Dual Pushbutton Switches (with pilot lights)

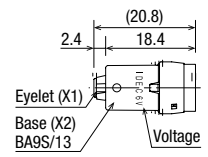

When ordering, specify the Ordering No.

Shape/Dimensions	Operating Voltage	Current Draw		Part No.	Ordering No.	Package Quantity	Base
		DC	AC				
 	6V AC/DC	7mA (R, A, W) 5.5mA (G, PW) 4.5mA (S)	8mA (except S) 7mA (S)	LSTD-6*	LSTD-6*	1	BA9S/13
					LSTD-6*PN10	10	
	12V AC/DC	10mA (except S) 8mA (S)	11mA (except S) 9mA (S)	LSTD-1*	LSTD-1*	1	
					LSTD-1*PN10	10	
	24V AC/DC	10mA (except S) 8mA (S)	11mA (except S) 9mA (S)	LSTD-2*	LSTD-2*	1	
					LSTD-2*PN10	10	

- Specify a color code in place of *. R (red), G (green), A (amber), W (white), S (blue), PW (pure white)

LED Lamps (LED Lamps for replacing incandescent lamps)

- Use the following replacement LED lamps to replace incandescent lamps.
- See HW series LED lamps shown above for ordering.
- LED lamps may have different brightness/color hue compared with incandescent lamps.

Incandescent Lamp				
Model (dimensions in mm)	Part No.	Rated Voltage	Lamp Ratings	Base
 Glass bulb: ø11 Length: 23	LS-6	6V AC/DC	1W(6V)	BA9S/13
	LS-8	12V AC/DC	1W(18V)	
	LS-2	AC/DC18V	1W(24V)	
	LS-3	24V AC/DC	1W(30V)	
LSB (For Jumbo Dome Pilot Lights)	LSB-2	24V AC/DC	28V/0.17A	BA9S/13
 Glass bulb: ø10 Length: 27				





Replacement LED Lamp		
Ordering No.	Rated Voltage	Base
LSRD-6	6V AC/DC	BA9S/13
LSRD-1	12V AC/DC	
LSRD-2	24V AC/DC	
LSRD-2	24V AC/DC	
LSTDB-2*	24V AC/DC	BA9S/13

- Specify a color code in place of *. R (red), G (green), A (amber), S (blue), PW (pure white)
- Use a PW (pure white) LED lamp for Y (yellow) illumination.
- When replacing the incandescent lamp with LSRD, the lens must also be replaced (see B-219).

For more information, visit <http://eu.idec.com>

Transformer

Package Quantity: 1

Shape	Operating Voltage	Operating Voltage Range	Ordering No.	Applicable Load
	100/110V AC	100/110V AC ±10%	TWR516	LSRD-6 (6V AC/DC, LED lamp) LSTD-6* (6V AC/DC, LED lamp) Specify a color code in place of * in Part No. R (red), G (green), A (amber), S (blue), PW (pure white)
	200/220V AC	200/220V AC ±10%	TWR526	
	400/440V AC	400/440V AC ±10%	TWR546	
	100/110V AC	100/110V AC ±10%	TWR512	LSRD-2 (24V AC/DC, LED lamp) LSTD-2* (24V AC/DC, LED lamp) or LSTDB-2* (24V AC/DC, LED lamp) Specify a color code in place of * in Part No. R (red), G (green), A (amber), S (blue), PW (pure white)
	200/220V AC	200/220V AC ±10%	TWR522	
	400/440V AC	400/440V AC ±10%	TWR542	

- Terminal cover (TWR-VL3) is installed on transformers as standard.
- Transformer is installed to one HW series unit.

Specifications

Part No.	TWR5□6	TWR5□2
Operating Voltage	100/110V AC, 200/220V AC 400/440V AC (50/60Hz)	
Current Draw	2.4VA	
Rated Insulation Voltage	600V	
Insulation Resistance	100MΩ minimum (500V DC megger)	
Operating Temperature	-30 to +60°C (no freezing)	
Operating Humidity	35 to 85% RH (no condensation)	
Storage Temperature	-40 to +80°C (no freezing)	
Vibration Resistance	Damage limits: 30Hz, amplitude 1.5 mm Operating extremes: 5 to 55Hz, amplitude 0.5 mm	
Shock Resistance	Damage limits: 1,000 m/s ² Operating extremes: 100 m/s ²	
Dielectric Strength	2500V AC, 1 minute	
Terminal Screw	M3.5	
Applicable Wire	2mm ² maximum, 2 wires maximum	
Weight (approx.)	87g	

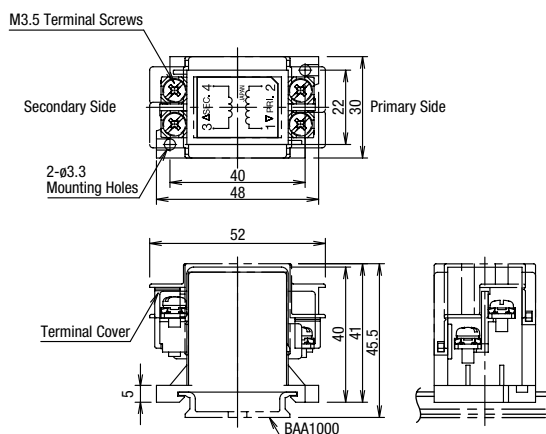

Dimensions



All dimensions in mm.

Accessories

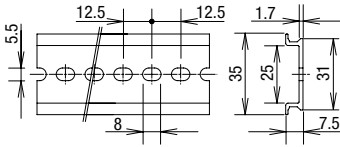
When ordering, specify the Ordering No.

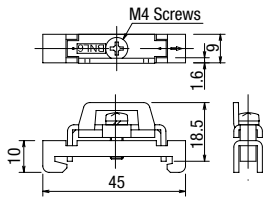
Shape	Material	Part No.	Ordering No.	Package Quantity	Dimensions (mm)
 <p>Weight: 200g approx.</p>	Aluminum Length: 1000 mm	BAA1000	BAA1000PN10	10	
 <p>Weight: 15g approx.</p>	Metal (zinc-plated steel) Applicable rail: AA1000 BAP1000	BNL6	BNL6PN10	10	

- See H-071 for DIN rail products.



- APEM
- Switches & Pilot Lights
- Control Boxes
- Emergency Stop Switches
- Enabling Switches
- Safety Products
- Explosion Proof
- Terminal Blocks
- Relays & Sockets
- Circuit Protectors
- Power Supplies
- LED Illumination
- Controllers
- Operator Interfaces
- Sensors
- AUTO-ID
- Flush Silhouette

ø16

ø22

ø30

Miniature

Pilot Lights

HW

TW

YW

Safety Precautions

- Turn off the power to the HW series switches & pilot lights before starting installation, removal, wiring, maintenance, and starting installation, removing, wiring, maintenance, and inspection of the products. Failure to turn power off may cause electrical shocks or fire hazard.
- To avoid a burn on your hand, use the lamp holder tool when replacing lamps.
- For wiring, use wires of a proper size to meet the voltage and current requirements. Tighten the terminal screws to the recommended tightening torque (see **B-228**). Failure to tighten terminal screws may cause overheat and fire.

Operating Instructions

Panel Mounting

- Remove the contact block from the operator (for transformer type pilot lights, remove the transformer from the illumination unit). Remove the locking ring from the operator (for pilot lights, remove the locking ring from the illuminated unit). Insert the operator into the panel cut-out from the front. Tighten the locking ring from the back to install the contact block to the operator.

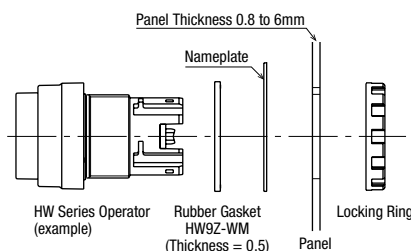

Mounting panel thickness is reduced by 1.5 mm when using a nameplate.

Removing the Contact Block

- Remove the safety lever lock (yellow) from the lock lever by inserting a flat screwdriver into the safety lever lock and push upwards.

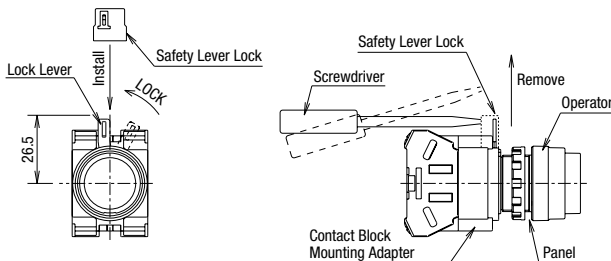

- Remove the operator from the contact block by turning the locking lever in the direction of the arrow shown below. Then the operator can be pulled out.

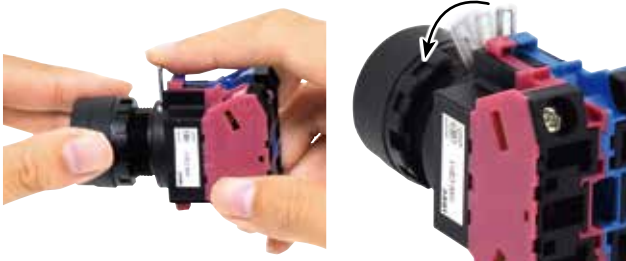

- To reinstall, place the TOP marking on the operator and the lock lever in the same direction, and insert the operator into the contact block mounting adapter. Then turn the locking lever in the opposite direction.
- Install the safety lever lock (yellow) on the lock lever. The safety lever lock cannot be installed when the lock lever is not upright.

Safety Lever Lock

IEEC strongly recommends using the safety lever lock (HW9Z-LS, yellow) to ensure that lock lever is locked, or to prevent maintenance personnel from unlocking contacts during wiring.



How to install

- Mount the HW series onto the panel, lock the lever, and push in the safety lever lock.

Spacing in Vertical Direction

- HW series can be installed with a minimum of 50 mm spacing in vertical direction (mono-lever switch: 70 mm minimum). Be sure to take the space required for installing/removing the safety lever lock into consideration. When the spacing is narrower than the recommended value, install the HW series units in the order of low to high. When removing, do so in the opposite direction.

Notes for Panel Mounting

Locking ring wrench recommended torque

Tighten the bezel to a tightening torque of 2.0 N·m.

Locking ring wrench

Locking ring wrench (MW9Z-T1) can be used to tighten the bezel. Do not use pliers. Excessive tightening will damage the locking ring.



Locking ring wrench (MW9Z-T1)

Panel Thickness

HW series can be mounted on a panel with thickness of 0.8 to 6.0 mm. Take the thickness of nameplate and/or switch guard into consideration.

Replacement of LED Lamps

LED lamps can be replaced by using the lamp holder tool (OR-55) from the front of the panel, or by removing the contact block from the operator unit. (See **B-217** for lamp holder tool.)

How to Remove

To remove, slip the lamp holder tool onto the lamp head lightly. Then push slightly, and turn the lamp holder tool counterclockwise.

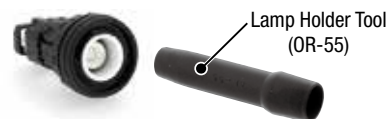
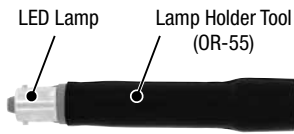

Photo: Extended pilot light

Operating Instructions

How to Install

Insert the lamp head into the lamp holder tool.



Place the pins on the lamp base to the grooves in the lamp socket. Insert the lamp and turn it clockwise.

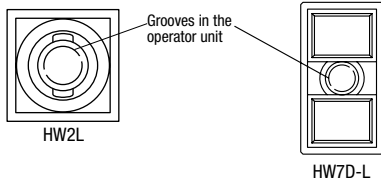

Installing/Removing the Buttons and Lenses

<To install>

<To remove>

Pushbutton Button

• Flush/Extended

Push in the button to install.



Insert a flat screwdriver between the button and the bezel to remove the button.



• Mushroom/Jumbo Mushroom

Button has threads. Turn clockwise to install the button.



Turn the button counterclockwise to remove.



Note: Jumbo mushroom button cannot be removed.

Illuminated Pushbutton Lens

• Flush/Extended

Push in the lens holder into the operator unit.



Insert a flat screwdriver between the button and the bezel to remove the lens holder.



• Mushroom/Jumbo Mushroom

Lens has threads. Turn clockwise to install the lens.



Lens has threads. Turn counterclockwise to remove the lens.



Pilot Light Lens

• Extended/Mushroom

Lens has threads. Turn clockwise to install the lens.



Turn the lens counterclockwise to remove.



• Round Flush/Square Flush

Push in the lens holder into the operator unit.



Insert a flat screwdriver between the lens and the bezel to remove.



Removing the Contact Blocks/Full Voltage Adapters

Insert a flat screwdriver (4 to 6 mm) into the snap-fit latches of the contact block or full voltage adapter and lift to remove.

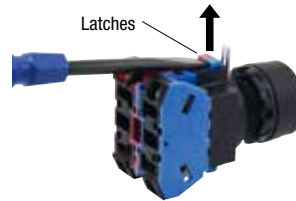

- Make sure to lift both latches. Contact blocks cannot be removed by lifting one latch only.
- Do not apply excessive force to the latches, otherwise damage may be caused.

Transformer Units and DC-DC Converters

Insert the end of the contact block removal tool (TW-KC1) into the snap-fit latch of the transformer units or DC-DC converter and pull the tool forward.

The contact block removable tool cannot be used to remove the HW-U contact blocks (HW-U), full voltage adapters (HW-GA1N), or dummy blocks (HW-DB).

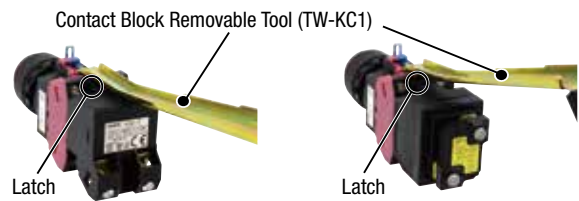

Transformer Units and DC-DC Converters for Pilot Lights

Insert a flat screwdriver into the snap-fit latch on the contact block and lift to remove.



⚠ When replacing parts (contact block, dummy block, full voltage adapter, transformer) for maintenance, make sure to install the parts to the original position. Otherwise proper operation cannot be guaranteed.



Operating Instructions

Using a Ring Adapter

HW9Z-A25

Install the ring adapter between the HW series unit and panel. Make sure that the side with ridges face the panel.



Nitryl Rubber

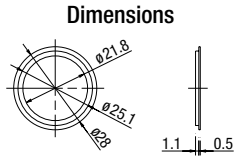

Installation

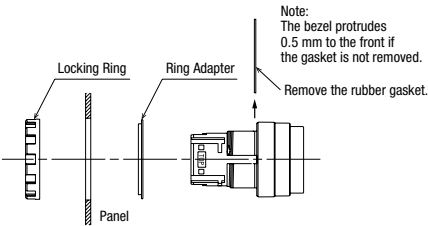

Panel Cut-out

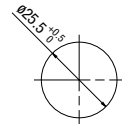

HW9Z-A30

The ring adapter HW9Z-A30 consists of a washer and adapter. Install adapter between the HW series unit and panel. Install washer between the locking ring and panel.

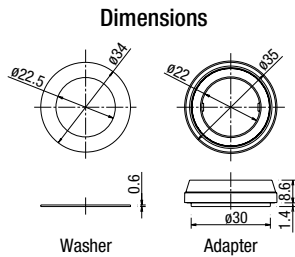
Washer:
metal (brass)Adapter:
polyamide

Installation

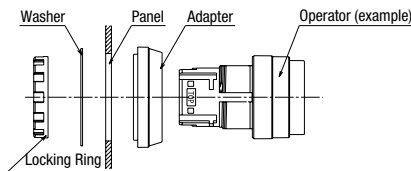

Panel Cut-out

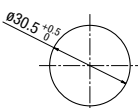

Removing the Lens

Remove the lens by pushing the lens from the rear to disengage the latches between the lens and the lens holder, using a flat screwdriver as shown below. Marking plate can be removed after the lens is removed from the lens holder.



Note: The translucent filter in the lens holder cannot be removed because this filter is sealed to make the unit waterproof and oiltight.

Installing

[For Round Lens]

Lens Marking Plate Lens Holder

- Place the marking plate on the lens holder with the anti-rotation projection engaged and press the lens onto the lens holder to engage the latches.
- Place the marking plate in the correct orientation.

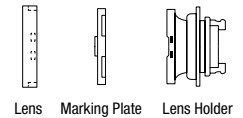

[For Square Lens]

Lens Marking Plate Lens Holder

- Place the marking plate on the lens holder and press the lens onto the lens holder to engage the latches.
- Place the marking plate in the correct orientation (note the directionality of marking plate).

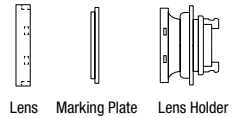

Marking

For HW series illuminated pushbuttons and pilot lights, legends and symbols can be engraved on the built-in marking plates, or printed film can be inserted under the lens for labeling purposes. Films are not supplied with illuminated pushbuttons, and may be provided by the user.

Lens Style	Round Lens (Round Flush/Round Flush with Square Bezel)	Square Lens (Square Flush)
Built-in Marking Plate	<p>Engraving Area $\phi 19.6$</p> <p>Outside diameter $\phi 21.5$</p>	<p>Engraving Area $\square 19.9$</p> <p>Outside diameter $\square 22.7$</p>
	<ul style="list-style-type: none"> Engraving must be made on the engraving area within 0.5 mm deep. The marking plate is made of white acrylic resin. 	
Applicable Marking Film	<p>$\phi 19.4$ 19.4</p>	<p>$\square 22.7$ 22.7</p>
	<ul style="list-style-type: none"> Two 0.1 mm-thick films or one 0.2 mm-thick film can be installed in the lens (marking film is not supplied and must be provided by the user). Recommended marking film: polyester 	

Replacement of Lens and Marking Plate

Removing the Lens Unit

Remove the lens unit (color lens, marking plate, and lens holder) by inserting a small flat screwdriver into the recess of the lens through the bezel. Knob on illuminated selector switches can be removed by tilting sideways. No tool is required.



APEM

Switches & Pilot Lights

Control Boxes

Emergency Stop Switches

Enabling Switches

Safety Products

Explosion Proof

Terminal Blocks

Relays & Sockets

Circuit Protectors

Power Supplies

LED Illumination

Controllers

Operator Interfaces

Sensors

AUTO-ID

Flush Silhouette

ø16

ø22

ø30

Miniature

Pilot Lights

HW

TW

YW

APEM

Switches & Pilot Lights

Control Boxes

Emergency Stop Switches

Enabling Switches

Safety Products

Explosion Proof

Terminal Blocks

Relays & Sockets

Circuit Protectors

Power Supplies

LED Illumination

Controllers

Operator Interfaces

Sensors

AUTO-ID

Flush Silhouette

ø16

ø22

ø30

Miniature

Pilot Lights

HW

TW

YW

Operating Instructions

Insertion Order of Marking Plate and Film

[Round Lens]

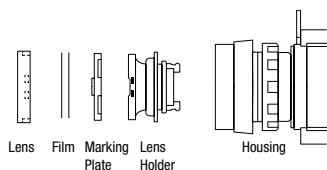

Note: Films are not supplied.

[Square Lens]

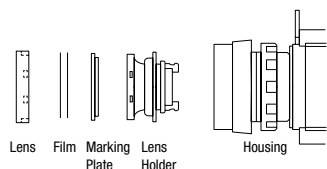

Note: Films are not supplied. When inserting a film, make sure that the marking plate is installed with its uneven side facing the lens holder.

Nameplate

Mounting panel thickness is reduced by 1.5 mm when using a nameplate.

Installing a Marking Plate

Insert a marking plate tin in the direction of the arrow ①, and press in as shown ②.

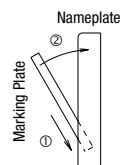

Removing a Marking Plate

Insert a flat screwdriver into the upper middle part of the marking plate and remove. When anti-rotation is not required, remove the projection from the nameplate using pliers.

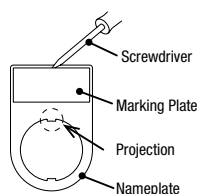

Replacing the Lens of Dual Pushbuttons

Removing

Remove the lens by inserting a small flat screwdriver into the recess of the lens through the bezel.



Installing

Install the lens in the recess between the buttons by pressing against the bezel.

Selector Switches

Turn the operator such as knob, lever, and key to each position accurately. Releasing halfway may cause the operator to return to the former position, or to get stuck between. On spring return two-way types, the center of operators may be misaligned slightly.

Key Selector Switches

Insert the key completely before turning. Failure to do so may cause failures.

Anti-rotation Ring and Panel Cut-out

Align the TOP marking on the operator, TOP marking on the anti-rotation ring with the recess in the mounting panel.

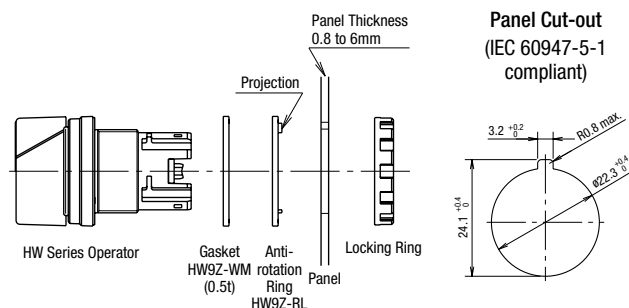

Dual Pushbutton Switches

The pushbuttons cannot be removed or replaced. Do not attempt to remove using a flat screwdriver or pliers, otherwise the pushbuttons may be damaged.

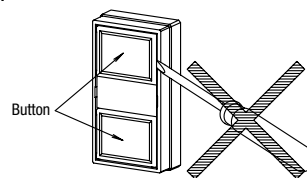

Installing the Rubber Boot for Dual Pushbuttons

When using the HW7D pushbuttons in places where the pushbuttons are subject to water splash or an excessive amount of dust, make sure to use the HW9Z-D7D rubber boot (IP65) which is ordered separately. Recomb the rubber gasket pre-installed on the operator, and install the rubber boot from the front of buttons.

Notes for Installing the Rubber Boot

Remove the gasket from the operator, and install the rubber boot on the operator. Pull out the seals of the rubber boot and place them around the operator sleeve as shown. Make sure that the seals are not twisted or tucked inside and that the gasket does not remain, otherwise the normal waterproof and dustproof characteristics are not ensured.

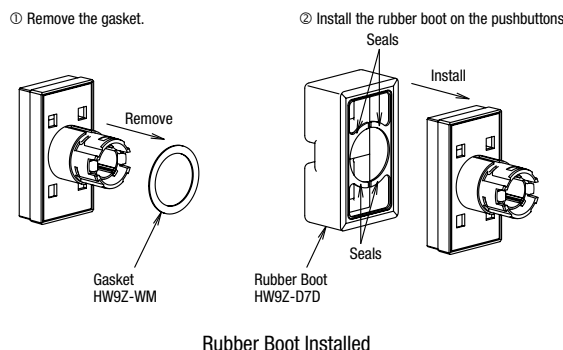

Operating Instructions

Close Mounting

When mounting the units closely in a horizontal row on 30 mm centers, use optional barriers to prevent interconnection between adjoining terminals, and to increase the creepage distance. The barriers can be attached simply by pressing them onto the sides of contact blocks.

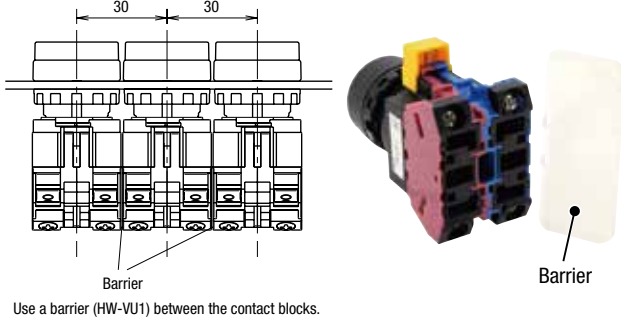

Note: Sufficient insulation distance cannot be obtained if barriers are not installed, or when other barriers such as HW-VG1 is used.

When using transformer type illuminated HW series of 240V AC maximum closely in a horizontal row on 30 mm centers, insert straight the solid wires or stranded wires into inside of the terminal screw on the transformer (see figure below) to prevent short circuit between adjoining terminals.

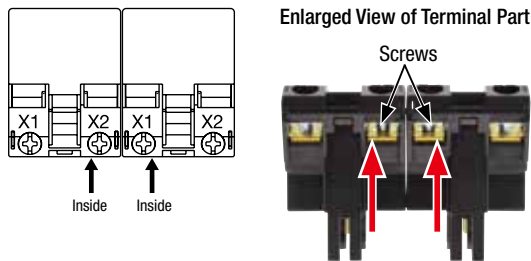

When using transformer type pilot lights closely mounted in horizontal and vertical rows on 30 mm centers, keep the ambient temperature below 40°C.

Applicable Wiring

(1) Contact Block 0.3 to 3.5 mm² (solid wire ø0.5 to 2.0 mm)

Pushbutton/illuminated pushbutton/dual pushbuttons (without pilot light), selector switch, illuminated selector switch, pushbutton selector, mono-lever switch

Ⓐ and Ⓑ show the wiring direction to the terminals.

<Contact Block>

Terminal screws M3.5 (spring-up)

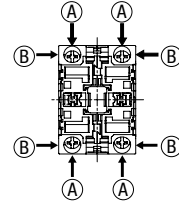

Applicable Crimping Terminal

Be sure to use an insulation tube or cover on the crimping part of the crimping terminal to prevent electrical shocks.

Crimping terminal for Ⓐ

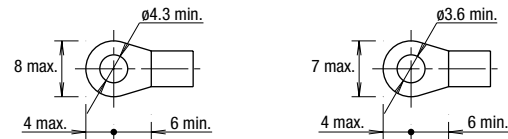

IP20 crimping terminal

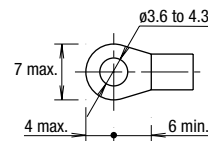

Crimping terminal for Ⓑ (IP20)

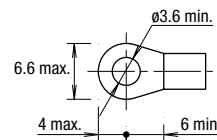

Solid wire

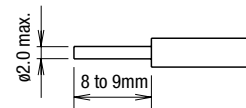

- Strip the wire insulation 8 to 9 mm from the end.
- Insert the wire until the insulation comes into contact with the terminal metal part.

(1)-1 IP20 Degree of Protection

The terminal of HW-U contact block has IP20 degree of protection. When IP20 is required for wiring, observe the followings. Make sure to insert the crimping terminal or wire to the terminal straight and fully.

When using a crimping terminal

Use IP20 crimping terminals.

When using a solid wire

Strip the wire insulation 8 to 9 mm from the end and insert the wire to the terminal fully.

When using a stranded wire

Strip the wire insulation 8 to 9 mm from the end and insert the wire to the terminal fully. Make sure that the wires are not loosened.

APEM

Switches & Pilot Lights

Control Boxes

Emergency Stop Switches

Enabling Switches

Safety Products

Explosion Proof

Terminal Blocks

Relays & Sockets

Circuit Protectors

Power Supplies

LED Illumination

Controllers

Operator Interfaces

Sensors

AUTO-ID

Flush Silhouette

ø16

ø22

ø30

Miniature

Pilot Lights

HW

TW

YW

Operating Instructions

(2) Power Unit 0.3 to 2 mm² (solid wire ø0.5 to 1.6 mm)

Illuminated pushbutton/illuminated selector switch

Ⓐ and Ⓑ show the wiring direction to the terminals.

<Full Voltage Adapter>

Terminal screws M3.5 (spring-up)

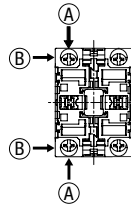

<Transformer Unit>

100/110V AC, 200/220V AC

Terminal screws M3.5 (spring-up)

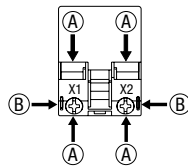

<DC-DC Converter Unit/Transformer Unit>

110V DC, 380V AC minimum

Terminal screws M3.5 (spring-up)

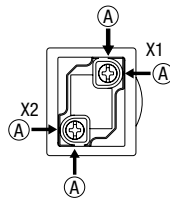

Applicable Crimping Terminal

Be sure to use an insulation tube or cover on the crimping part of the crimping terminal to prevent electrical shocks.

Crimping terminal for Ⓐ

Crimping terminal for Ⓑ

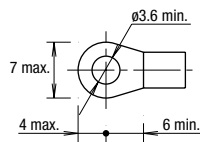
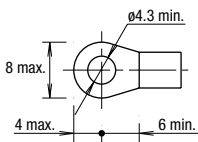

Solid wire

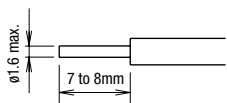

- Strip the wire insulation 7 to 8 mm from the end.
- Insert the wire until the insulation comes into contact with the terminal metal part.

Terminal cover is integrated in the full voltage adapter and transformer unit. Note that the connection terminal is not IP20.

(2) Pilot Light 0.3 to 2 mm² (solid wire ø0.5 to 1.6 mm)

(Arrows show the wiring direction)

<Full Voltage Adapter>

6, 12, 24V AC/DC

Terminal screws M3.5 (spring-up)

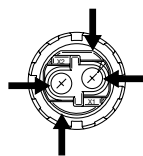

<Transformer, DC-DC Converter>

100/110V AC, 200/220V AC

110V DC, 380V AC minimum

Terminal screws M3.5 (spring-up)

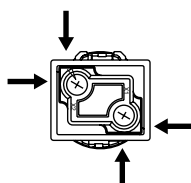

Applicable Crimping Terminal

Be sure to use an insulation tube or cover on the crimping part of the crimping terminal to prevent electrical shocks.

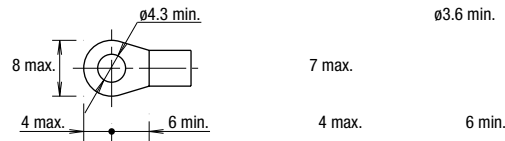

Solid Wire

- Strip the wire insulation 8 to 9 mm from the end.
- Inset the wire until the insulation comes into contact with the terminal metal part.
- Terminal cover is integrated but not IP20.
- When selecting mounting centers and crimping terminals, take sufficient insulation distance into consideration.

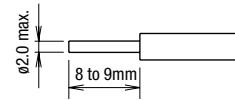

Cautions for Wiring

About DC-DC Converter Unit

1. Note the polarity for wiring when connecting to the DC-DC converter.

Terminal No.	Polarity
X1	Positive
X2	Negative

2. Incandescent lamps cannot be used in DC-DC converter unit.

3. DC-DC converters are equipped with an electric circuit and noise may be heard inside the unit, which does not affect the performance of DC-DC converters.

Recommended Tightening Torque Number of Wires

Unit	Wire	Number of Wires	Recommended Tightening Torque	Terminal Screw	
HW-U Contact Block	Crimping Terminal	2	1.0 to 1.3	M3.5	
	Solid Wire	ø0.5 to 1.6 mm (AWG14 to 22)	2		1.0 to 1.3
		ø1.7 to 2.0 mm (AWG12)	1		1.2 to 1.3
	Stranded Wire	0.3 to 2.0 mm ² (AWG14 to 22)	2		1.0 to 1.3
2.1 to 3.5 mm ² (AWG12)		1	1.2 to 1.3		
Illuminated Unit (*1)	Crimping Terminal	2	1.0 to 1.3	M3.5	
	Solid Wire ø0.5 to 1.6 mm (AWG14 to 22)				
Pilot Light	Crimping Terminal	2	1.0 to 1.3	M3.5	
	Solid Wire ø0.5 to 1.6 mm (AWG14 to 22)				
	Stranded Wire 0.3 to 2.0 mm ² (AWG14 to 22)				

*1) Lamp terminal of illuminated pushbuttons, illuminated selector switches, dual pushbuttons with pilot lights