

A B E G Q



Self Priming Centrifugal Pump

Models 03H1-GL, 03H1-GR, 03H3-GL and 03H3-GR

Size 3" x 3"

PUMP SPECIFICATIONS

Size: 3" x 3" (76 mm x 76 mm) NPT - Female.

Casing: (03H1) Aluminum Alloy 356-T6.
(03H3) Ductile Iron 60-40-18.

Maximum Operating Pressure 176 psi (1214 kPa).*

Enclosed Type, Five Vane Impeller: Aluminum Alloy 356-T6
Handles 7/16" (11,1 mm) Diameter Spherical Solids.

Pinion Shaft: Alloy Steel 4150.

Shaft Sleeve: Alloy Steel 4130.

Replaceable Wear Ring: Copper Alloy C93200.

Seal Plate: (03H1) Gray Iron 30.
(03H3) Ductile Iron 60-40-18.

Seal Guard: Copper Alloy C26000.

Gearbox Housing: Gray Iron 30.

Gearbox Lubrication: SAE 90 Gear Oil.

Gear: Alloy Steel 4620.

Gear Ratio: 4.09:1 Increase.

Bearings: Open Single Row Ball.

Flanges: (03H1) Aluminum Alloy 356-T6.
(03H3) Ductile Iron 60-40-18.

Gaskets: Cork ^w/Nitrile and Vegetable Fiber.

O-Rings: Buna-N.

Hardware: Standard Plated Steel.

Optional Equipment: Victaulic[®] Suction and Discharge Flanges.
Horizontal Victaulic[®] Discharge Flange.

Victaulic[®] is a Registered Trademark of Victaulic Company of America.

**Consult Factory for Applications Exceeding
Maximum Pressure and/or Temperature Indicated.*

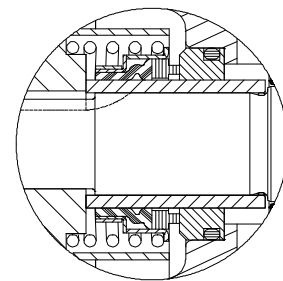
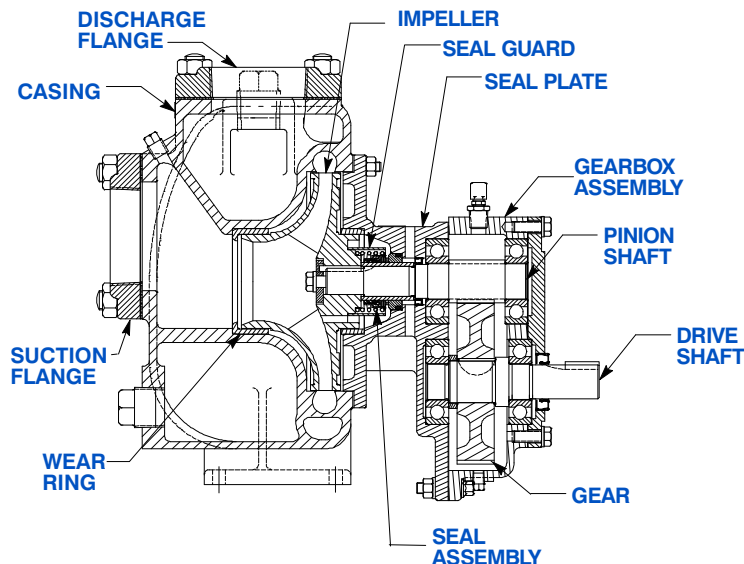

SEAL DETAIL

Type 2, Mechanical, Self-Lubricated. Carbon Rotating Face. Ni-Resist Stationary Face. Fluorocarbon Elastomers (DuPont Viton[®] or Equivalent). Stainless Steel 18-8 Cage and Spring. Maximum Temperature of Liquid Pumped, 160°F (71°C).*



THE GORMAN-RUPP COMPANY • MANSFIELD, OHIO

GORMAN-RUPP OF CANADA LIMITED • ST. THOMAS, ONTARIO, CANADA

www.grpumps.com

Specifications Subject to Change Without Notice

Printed in U.S.A.

Specification Data

APPROXIMATE
DIMENSIONS and WEIGHTS

NET WEIGHT:

03H1-GL & 03H1-GR
68 LBS. (33,5 KG.)

03H3-GL & 03H1-GR
104 LBS. (47,1 KG.)

SHIPPING WEIGHT:

78 LBS. (39,4 KG.)

114 LBS. (51,7 KG.)

EXPORT CRATE SIZE:

3.5 CU. FT. (0,10 CU. M.)

SECTION 110, PAGE 600

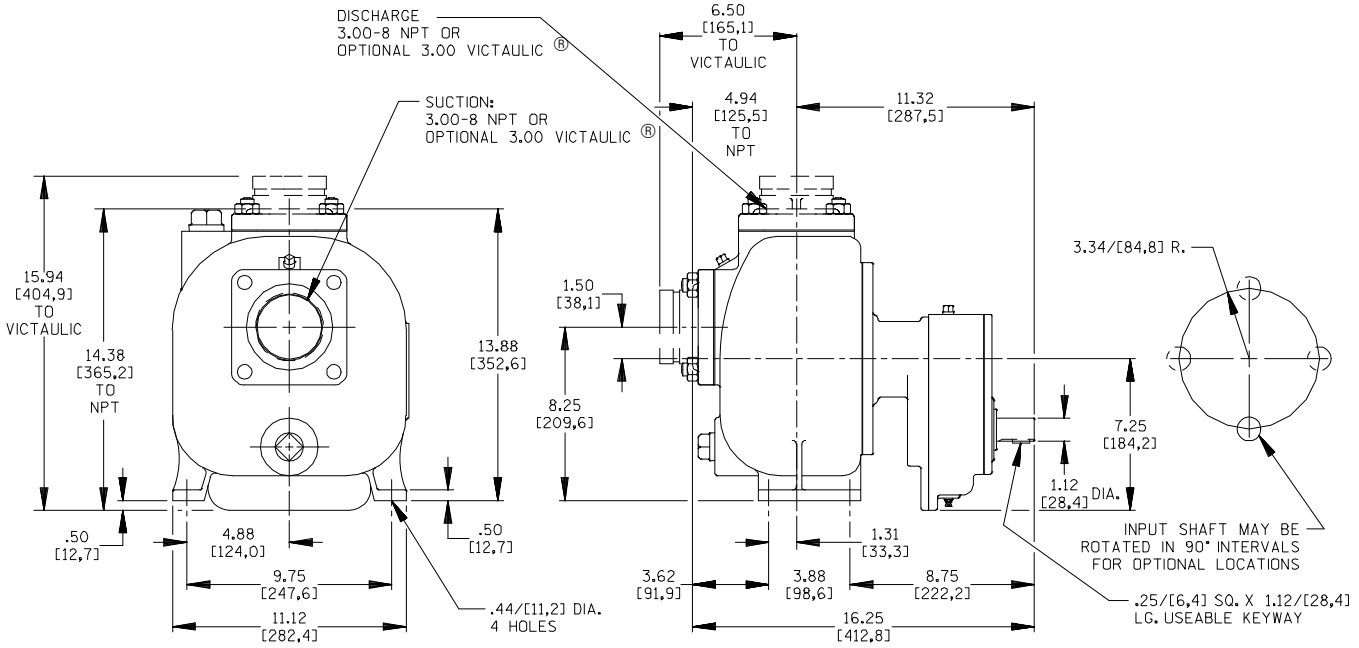

Victaulic® is a Registered Trademark of Victaulic Company of America.

NOTE:
INPUT SHAFT ROTATION CLOCKWISE FOR MODELS 03H-GR.
INPUT SHAFT ROTATION COUNTER-CLOCKWISE FOR MODEL 03H-GL.

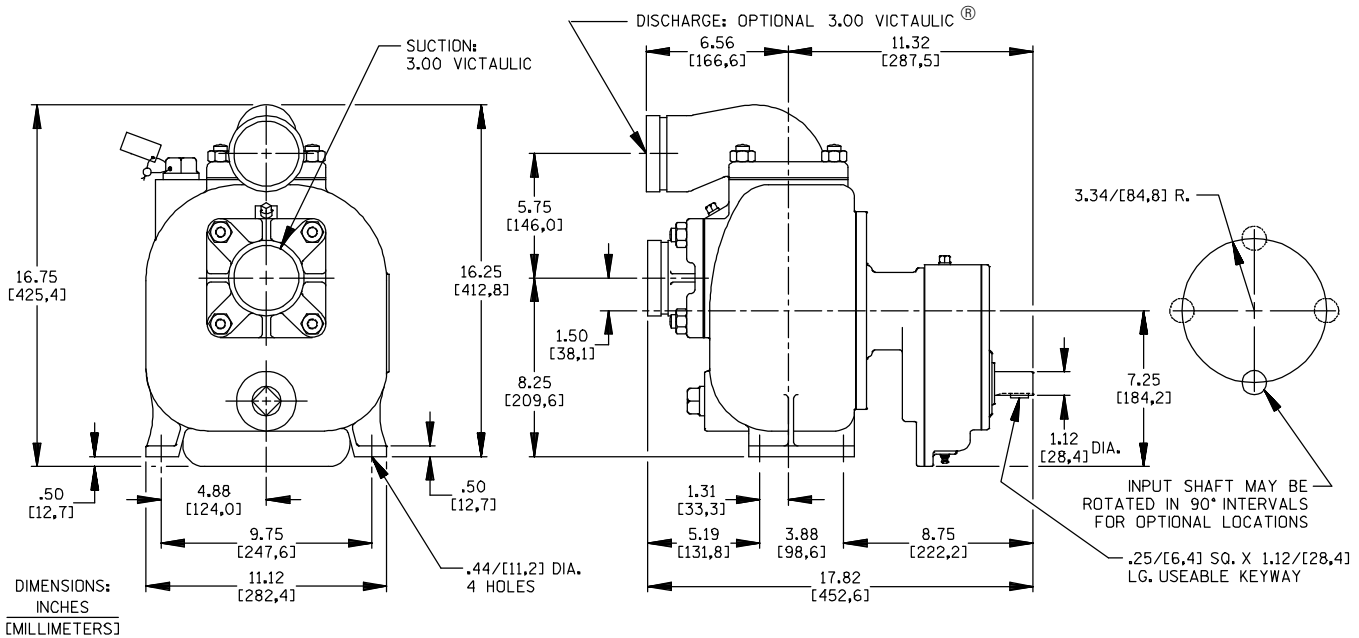

DIMENSIONS:
INCHES
[MILLIMETERS]

Shown with Optional Horizontal Victaulic® Elbow.

NOTE:
INPUT SHAFT ROTATION CLOCKWISE FOR MODELS 03H-GR.
INPUT SHAFT ROTATION COUNTER-CLOCKWISE FOR MODEL 03H-GL.
DISCHARGE ELBOW MAY BE ROTATED TO FRONT (AS SHOWN), REAR, OR TO SIDE OPPOSITE FILL PLUG.

Victaulic® is a Registered Trademark of Victaulic Company of America.



THE GORMAN-RUPP COMPANY • MANSFIELD, OHIO

GORMAN-RUPP OF CANADA LIMITED • ST. THOMAS, ONTARIO, CANADA

Specifications Subject to Change Without Notice

Printed in U.S.A.

A B E G Q

PERFORMANCE
BASED ON
PETROLEUM

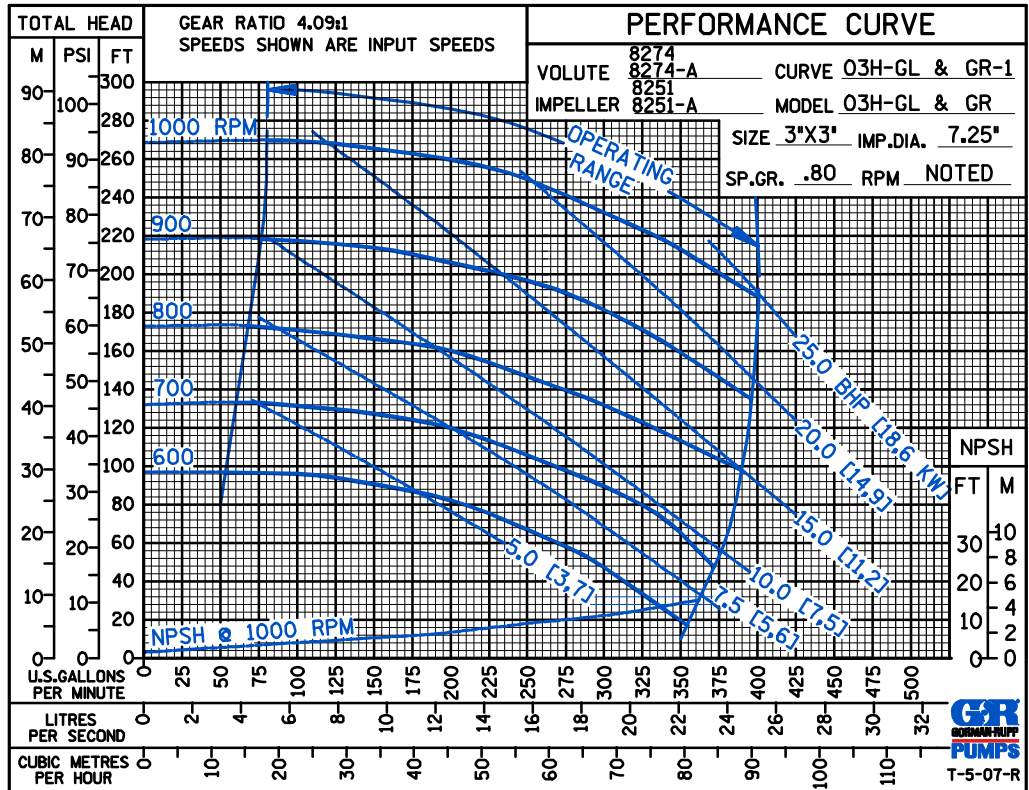

PERFORMANCE
BASED ON
WATER

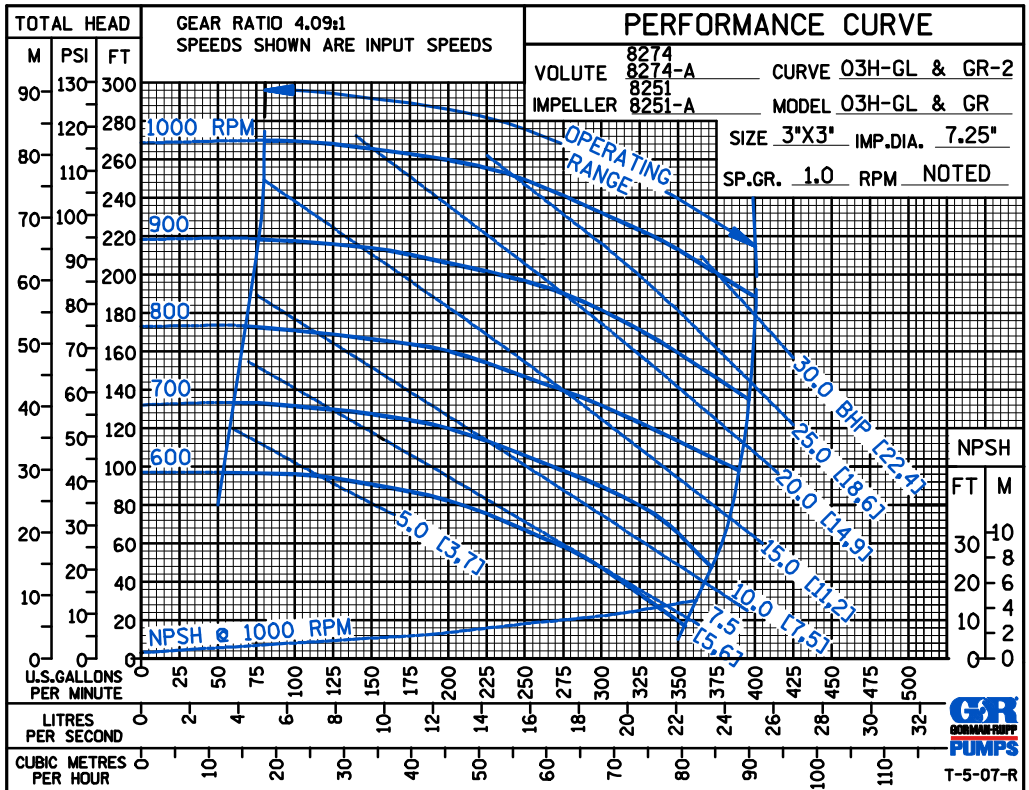

THE GORMAN-RUPP COMPANY • MANSFIELD, OHIO

GORMAN-RUPP OF CANADA LIMITED • ST. THOMAS, ONTARIO, CANADA

Specifications Subject to Change Without Notice

Printed in U.S.A.